



Garden & Storage

Garden Shed: Lagos 100

RF2236050 + RF2238210



Instruction manual



Montage handleiding



Montageanleitung



Manuel d'instruction

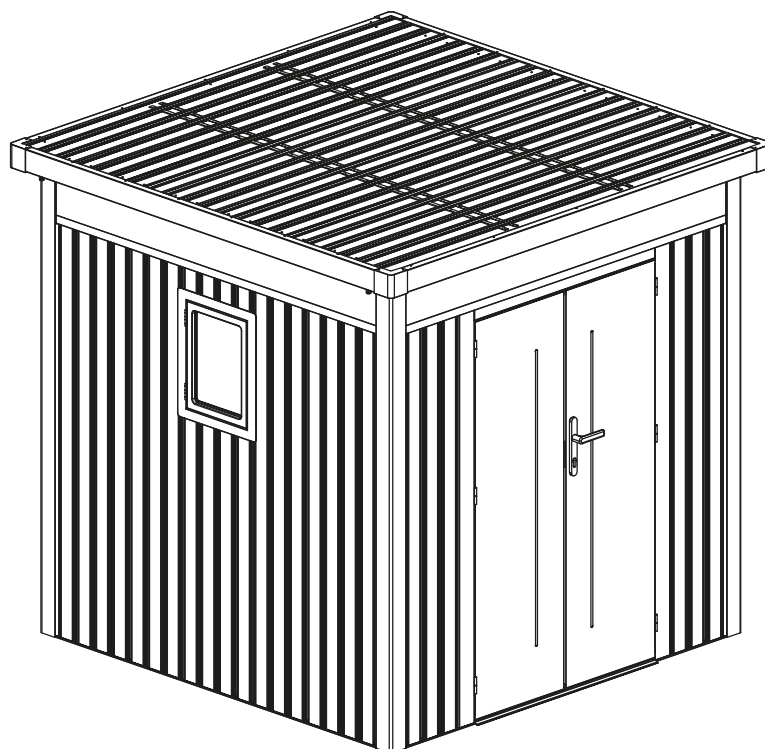

Important Information:

Prior to assembling your garden shed, please be aware that assembly may require building permits, depending on the location and surface area. It is crucial to consult with your local authorities to obtain the necessary information before proceeding with the assembly.

Weather Conditions:

We advise you not to use this product as a shelter in extreme weather conditions. In the case of strong winds or snow, we advise locking windows and doors. Subsequently clear any snow on the roof as soon as possible to prevent any damage.

This garden shed is resistant to most weather conditions and can withstand heavy rain. However, exceptional conditions can compromise the water sealing of the product. It is, therefore, deemed acceptable that some water ingress may be possible during certain conditions.

Warranty Information:

The warranty applies to manufacturers defects and covers the replacement of spare parts or the provided product, no refunds will be issued. The manufacturers warranty does not cover:

- Normal wear and tear.
- Loss or breakage during unpacking or installation.
- Lack of care, neglect, vandalism, impact with foreign objects, contact with abrasive materials, aesthetics, incorrect assembly or disassembly, rebuilding, or relocation and including and not limited to all points mentioned in the above weather conditions paragraph.
- Force majeure events like hail, high winds, storms, snow, floods, lightning, etc.
- Modifying the product voids the warranty; user-tampered products are not covered.

All warranty claims must be directed to the point of sale (store or website) where your product was purchased.

Please ensure you send the following details:

- Proof of purchase
- A detailed description of the problem.
- Clear and complete pictures of the problem.

Your claim will then be assessed accordingly.

Product Assembly Guidelines:

- We advise you to read the instructions very carefully before proceeding to assemble the garden shed.
- Carefully select the location, avoiding rainy days, prevailing winds, and overhanging trees. We recommend you also check the surrounding area for any possible obstructions which may be near or within the product placement.
- Mount on a flat and level foundation, preferably on concrete slab or concrete supports along the whole width and length of the flooring profiles.
- Ensure at least 2/3 individuals are present during assembly.
- Keep children away from the assembly area.
- Exercise caution to avoid the risk of pinching.
- Follow all assembly steps meticulously and verify the structure's level on all sides.
- Do not anchor before completing the entire assembly process, we recommend you re-check tightness of all fasteners and the level of the complete shed before doing so.
- Properly anchor the garden shed to the ground or foundation using (expansion)screws and/or plugs.
- To avoid any damages and injuries, please do not climb on the roof.
- Please ensure that you retain the instruction manual and do not throw it away after assembly.
- The user is liable for any damages or injuries caused due to incorrect or improper installation.

Pre-Assembly Checklist:

Before starting the assembly, please ensure:

- All listed parts are supplied and undamaged.
- Report any missing parts within 14 days of delivery AND before assembly!
- For reporting missing parts, please contact your point of sale (store or website) where your product was purchased.
- Do not discard the packaging without confirming the proper functioning of the product.

Maintenance Recommendations:

To ensure longevity and aesthetic appeal, regular maintenance is essential.

We recommend:

- Cleaning with fresh water using a soft sponge or cloth once or twice a year (or more).
- Avoid using detergents or abrasive materials during cleaning.
- Regularly checking the tightness of screws (at least once a year).
- Applying WD-40 (or similar product) to fasteners to clean and increase surface rust resistance
- Ensuring unobstructed water flow in gutters (clearing leaves, branches, etc.).

Belangrijke informatie:

Voordat u uw tuinhuis monteert, dient u zich ervan bewust te zijn dat de bouw mogelijk een bouwvergunning vereist, afhankelijk van de locatie en oppervlakte. Het is cruciaal om voorafgaand aan de montage contact op te nemen met de lokale autoriteiten om de benodigde informatie te verkrijgen.

Weersomstandigheden:

Wij adviseren u om dit product niet als schuilplaats te gebruiken bij extreme weersomstandigheden.

Bij sterke wind of sneeuw adviseren wij om ramen en deuren af te sluiten.

Verwijder vervolgens zo snel mogelijk alle sneeuw van uw pergola om schade te voorkomen.

Deze tuinhuis is bestand tegen de meeste weersomstandigheden en kan zware regenval weerstaan. Uitzonderlijke omstandigheden kunnen echter de waterdichtheid van het product in gevaar brengen. Het wordt daarom aanvaardbaar geacht dat onder bepaalde omstandigheden enige waterindringing mogelijk is.

Garantie-informatie:

De fabrieksgarantie geldt voor fabrieksdefecten en omvangt de vervanging van reserveonderdelen of het geleverde product, er worden geen restituties verstrekt. De fabrieksgarantie dekt niet:

- Normale slijtage.
- Verlies of breuk tijdens het uitpakken of installeren.
- Gebrek aan zorg, verwaarlozing, vandalisme, impact met externe objecten, contact met schurende materialen, esthetiek, onjuiste montage of demontage, herbouw of verplaatsing en inclusief maar niet beperkt tot alle punten genoemd in de bovenstaande alinea over weersomstandigheden.
- Overmachtgebeurtenissen zoals hagel, harde wind, stormen, sneeuw, overstromingen, bliksem, etc.
- Het wijzigen van het product maakt de garantie ongeldig; door de gebruiker gemanipuleerde producten vallen niet onder de dekking.

Alle garantieclaims moeten worden gericht aan het verkooppunt (winkel of website) waar uw product is gekocht.

Zorg ervoor dat u de volgende gegevens meestuurt:

- Aankoopbewijs
- Een gedetailleerde beschrijving van het probleem.
- Duidelijke en volledige foto's van het probleem.

Uw claim wordt dan zorgvuldig beoordeeld.

Product Assemblage Richtlijnen:

- Wij adviseren u om de instructies zeer zorgvuldig te lezen voordat u overgaat tot het monteren van de tuinhuis.
- Selecteer de locatie zorgvuldig, vermijd regenachtige dagen, overheersende winden en overhangende bomen. We raden u ook aan om de omliggende omgeving te controleren op mogelijke obstakels die zich in de buurt van of binnen de plaatsing van het product kunnen bevinden.
- Plaats op een vlakke en egale fundering, bij voorkeur op een betonnen plaat, tegels of gebruik van opsluitbanden onder de gehele breedte en lengte van het product.
- Zorg ervoor dat er minstens 2/3 personen aanwezig zijn tijdens de montage.
- Houd kinderen uit de buurt van het montagegebied.
- Wees voorzichtig om het risico op beknelling te vermijden.
- Volg alle montageschappen nauwgezet en controleer meermalig het waterpas niveau en hoeken van de structuur aan alle zijden tijdens montage.
- Veranker niet voordat het gehele montageproces is voltooid, we raden aan om de stevigheid van alle bevestigingsmiddelen en het niveau van de complete tuinhuis opnieuw te controleren.
- Veranker de tuinhuis op de juiste manier aan de grond of fundering met behulp van (expansie)schroeven en/of pluggen.
- Om schade en letsel te voorkomen, klim niet op het dak.
- Zorg ervoor dat u de instructiehandleiding bewaart en deze niet weggooit na de montage.
- De gebruiker is aansprakelijk voor eventuele schade of letsel veroorzaakt door onjuiste of onjuiste installatie.

Montage voorbereiding/ Controlelijst:

Voordat u met de montage begint, zorg ervoor dat:

- Alle vermelde onderdelen zijn geleverd en onbeschadigd zijn.
- Meld ontbrekende onderdelen binnen 14 dagen na levering EN voor de montage!
- Voor het melden van ontbrekende onderdelen, neem contact op met het verkooppunt (winkel of website) waar uw product is gekocht.
- Gooi de verpakking niet weg zonder de goede werking van het product te bevestigen.

Onderhoudsadviezen:

Om de levensduur en esthetische aantrekkingskracht te waarborgen, is regelmatig onderhoud essentieel.

Wij raden aan:

- Schoon te maken met schoon water, met een zachte spons of doek een- of tweemaal per jaar (of vaker).
- Vermijd het gebruik van reinigingsmiddelen of schurende materialen tijdens het reinigen.
- Controleer regelmatig de stevigheid van schroeven (minstens eenmaal per jaar).
- Het aanbrengen van WD-40 (of een vergelijkbaar product) op bevestigingsmiddelen om ze schoon te maken en de oppervlakteroestbestendigheid te verhogen.
- Zorg voor een onbelemmerde waterafvoer in dakgoten (bladeren, takken, enz. verwijderen).

Wichtige Informationen:

Bevor Sie Ihre Gerätehaus zusammenbauen, beachten Sie bitte, dass je nach Standort und Fläche möglicherweise Baugenehmigungen erforderlich sind. Es ist entscheidend, sich vor dem Zusammenbau mit den örtlichen Behörden zu beraten, um die erforderlichen Informationen zu erhalten.

Wetterbedingungen:

Wir raten Ihnen, dieses Produkt bei extremen Wetterbedingungen nicht als Unterschlupf zu verwenden. Bei starkem Wind oder Schnee empfehlen wir, Fenster und Türen zu schließen. Entfernen Sie dann so schnell wie möglich alle Schnee von Ihrer Pergola, um Schäden zu vermeiden.

Diese Gerätehaus ist gegen die meisten Wetterbedingungen beständig und kann starken Regen standhalten. Allerdings können außergewöhnliche Umstände die Wasserdichtigkeit des Produkts beeinträchtigen. Es wird daher als akzeptabel angesehen, dass unter bestimmten Umständen etwas Wasser eindringen kann.

Garantieinformationen:

Die Herstellergarantie gilt für Fabrikmäängel und umfasst den Ersatz von Ersatzteilen oder der gelieferten Produkt ab, keine Rückerstattungen werden gewährt. Die Herstellergarantie deckt nicht:

- Normale Abnutzung.
- Verlust oder Bruch während des Auspackens oder der Installation.
- Mangelnde Pflege, Vernachlässigung, Vandalismus, Aufprall mit Fremdkörpern, Kontakt mit abrasiven Materialien, ästhetische Probleme, falsche Montage oder Demontage, Wiederaufbau oder Verschiebung und einschließlich, jedoch nicht beschränkt auf alle Punkte, die im obigen Abschnitt zu den Wetterbedingungen genannt werden.
- Höhere Gewalt wie Hagel, starke Winde, Stürme, Schnee, Überschwemmungen, Blitz usw.
- Eine Änderung des Produkts führt zum Erlöschen der Garantie; vom Benutzer manipulierte Produkte sind nicht abgedeckt.

Alle Garantieansprüche müssen an den Verkaufspunkt (Geschäft oder Website) gerichtet werden, wo Ihr Produkt gekauft wurde. Stellen Sie sicher, dass Sie die folgenden Informationen angeben:

- Kaufbeleg
- Eine detaillierte Beschreibung des Problems.
- Klare und vollständige Fotos des Problems.

Anschließend wird Ihr Garantie Reklamation sorgfältig geprüft.

Montagerichtlinien für das Produkt:

- Wir empfehlen Ihnen, die Anleitung sorgfältig zu lesen, bevor Sie mit dem Aufbau des Gerätehaus beginnen.
- Wählen Sie den Standort sorgfältig aus und vermeiden Sie Regentage, vorherrschende Winde und überhängende Bäume. Wir empfehlen Ihnen außerdem, die Umgebung auf mögliche Hindernisse in der Nähe oder innerhalb der Produktplatzierung zu überprüfen.
- Legen Sie auf einem flachen und ebenen Untergrund, vorzugsweise auf einer Betonplatte, Fliesen oder verwenden Sie Rasenkantenstein unter der gesamten Breite und Länge des Produkts.
- Stellen Sie sicher, dass bei der Installation mindestens 2/3 Personen anwesend sind.
- Halten Sie Kinder vom Montagebereich fern.
- Achten Sie darauf, Quetschgefahr zu vermeiden.
- Befolgen Sie alle Montageschritte sorgfältig und überprüfen Sie während der Montage mehrmals die Höhe und Winkel der Struktur auf allen Seiten.
- Verankern Sie erst, nachdem der gesamte Installationsvorgang abgeschlossen ist. Wir empfehlen, den festen Sitz aller Befestigungselemente und die Höhe der gesamten Gerätehaus erneut zu überprüfen.
- Verankern Sie das Gerätehaus mit Bolzenanker, Schrauben und/oder Dübeln fachgerecht im Boden oder Fundament.
- Um Schäden und Verletzungen zu vermeiden, klettern Sie nicht auf das Dach.
- Bewahren Sie die Bedienungsanleitung unbedingt und werfen Sie sie nach der Installation nicht weg.
- Der Benutzer haftet für Schäden oder Verletzungen, die durch eine fehlerhafte oder fehlerhafte Installation verursacht werden.

Vor-Montage-Checkliste:

Bevor Sie mit der Montage beginnen, stellen Sie bitte sicher:

- Alle aufgeführten Teile sind vorhanden und unbeschädigt.
- Melden Sie fehlende Teile innerhalb von 14 Tagen nach Lieferung UND vor der Montage!
- Für die Meldung fehlender Teile wenden Sie sich bitte an den Verkaufspunkt (Geschäft oder Website), an dem Ihr Produkt gekauft wurde.
- Werfen Sie die Verpackung nicht weg, ohne die ordnungsgemäße Funktion des Produkts zu bestätigen.

Wartungsempfehlungen:

Um Langlebigkeit und ästhetischen Reiz sicherzustellen, ist regelmäßige Wartung unerlässlich.

Wir empfehlen:

- Ein- oder zweimal im Jahr (oder öfter) mit klarem Wasser und einem weichen Schwamm oder Tuch zu reinigen.
- Verwenden Sie während der Reinigung keine Reinigungsmittel oder abrasive Materialien.
- Überprüfen Sie regelmäßig die Festigkeit der Schrauben (mindestens einmal im Jahr).
- Tragen Sie WD-40 (oder ein ähnliches Produkt) auf die Befestigungen auf, um sie zu reinigen und die Oberflächenrostbeständigkeit zu erhöhen.
- Stellen Sie sicher, dass das Regenwasser in den Regenrinnen ungehindert fließen kann (entfernen Sie Blätter, Äste usw.).
- Entfernen Sie stehendes Wasser um die Beine der Pergola, um Stagnation zu verhindern (heben Sie die Pfosten deckel an).



Informations importantes:

Avant d'assembler votre abri de jardin, sachez que la construction peut nécessiter des permis de construire, en fonction de l'endroit et de la surface. Il est essentiel de consulter les autorités locales pour obtenir les informations nécessaires avant de procéder à l'assemblage.

Conditions météorologiques:

Nous vous déconseillons d'utiliser ce produit comme abri dans des conditions climatiques extrêmes. En cas de vent fort ou de neige, nous vous recommandons de fermer les fenêtres et les portes. Retirez ensuite toute la neige de votre pergola le plus rapidement possible pour éviter tout dommage.

Cet abri de jardin peut résister à la plupart des conditions météorologiques et aux fortes pluies. Toutefois, des circonstances exceptionnelles peuvent compromettre l'étanchéité du produit. Il est donc considéré comme acceptable qu'une certaine infiltration d'eau soit possible dans certaines circonstances.

Informations sur la garantie:

La garantie constructeur s'applique aux défauts de fabrication et couvre le remplacement des pièces détachées ou des produit fourni ; aucun remboursement ne sera effectué. La garantie du fabricant ne couvre pas :

- L'usage normale.
- Perte ou casse lors du déballage ou de l'installation.
- Manque d'entretien, négligence, vandalisme, choc avec des objets externe, contact avec des matériaux abrasifs, esthétique, montage ou démontage incorrect, reconstruction ou déplacement, y compris, tous les points mentionnés dans le paragraphe ci-dessus relatif aux conditions météorologiques.
- Les événements de force majeure tels que la grêle, les vents violents, les tempêtes, la neige, les inondations, la foudre, etc.
- La modification du produit annule la garantie ; les produits altérés par l'utilisateur ne sont pas couverts.

Toutes les demandes de garantie doivent être adressées au point de vente (magasin ou site web) où votre produit a été acheté. Assurez-vous d'inclure les informations suivantes :

- Preuve d'achat
- Une description détaillée du problème.
- Photos claires et complètes du problème.

Votre réclamation sera ensuite soigneusement évaluée.

Directives d'assemblage du produit:

- Nous vous conseillons de lire très attentivement les instructions avant de procéder au montage de l'abri de jardin.
- Choisissez soigneusement l'emplacement, en évitant les jours de pluie, les vents dominants et les arbres en surplomb. Nous vous recommandons également de vérifier la zone environnante pour voir s'il n'y a pas d'obstacles qui pourraient se trouver à proximité ou à l'intérieur de l'emplacement du produit.
- Sur une fondation plane et de niveau, de préférence sur une dalle en béton, poser des dalles ou utiliser des sangles de maintien sous toute la largeur et la longueur du produit.
- Assurez-vous qu'au moins 2/3 personnes soient présentes pendant le montage.
- Tenez les enfants à l'écart de la zone de montage.
- Attention à éviter tout risque d'écrasement.
- Suivez attentivement toutes les étapes de montage et vérifiez plusieurs fois le niveau et les angles de la structure de tous les côtés pendant le montage.
- Ne pas ancrer tant que tout le processus d'assemblage n'est pas terminé, nous vous recommandons de révéifier le serrage de toutes les fixations et le niveau de l'abri de jardin complet.
- Ancrez correctement l'abri de jardin au sol ou aux fondations à l'aide de vis (à expansion) et/ou de chevilles.
- Pour éviter tout dommage ou blessure, ne montez pas sur le toit.
- Pour toute référence future et pour l'entretien, veuillez à conserver le manuel d'instructions et à ne pas le jeter après l'assemblage
- L'utilisateur est responsable de tout dommage ou blessure causé par un assemblage et/ou une installation incorrects.

Préparation de l'assemblage/ Liste de controle:

Avant de commencer l'assemblage, veuillez vous assurer que:

- Toutes les pièces énumérées sont fournies et intactes.
- Signalez toute pièce manquante dans les 14 jours dès réception de votre commande ET avant l'assemblage !
- Pour signaler les pièces manquantes, veuillez envoyer un mail au point de vente (magasin ou site web) où votre produit a été acheté.
- Ne jetez pas l'emballage sans avoir confirmé le bon fonctionnement du produit.

Recommandations d'entretien:

Pour garantir la longévité et l'attrait esthétique, un entretien régulier est essentiel.

Nous recommandons :

- Nettoyer à l'eau claire, à l'aide d'une éponge ou d'un chiffon doux, une à deux fois par an (ou plus souvent).
- Éviter d'utiliser des détergents ou des matériaux abrasifs lors du nettoyage.
- Vérifier régulièrement le serrage des vis (au moins une fois par an).
- Appliquer du WD-40 (ou un produit similaire) sur les fixations pour les nettoyer et augmenter la résistance à la rouille en surface.
- Assurez que l'eau s'écoule librement dans les gouttières (enlevez les feuilles, les branches, etc.).

Required equipment/ Benodigde materialen/ Benötigte Ausrüstung/ Équipement requis

Tools/ Gereedschap/ Werkzeug/ Outils:

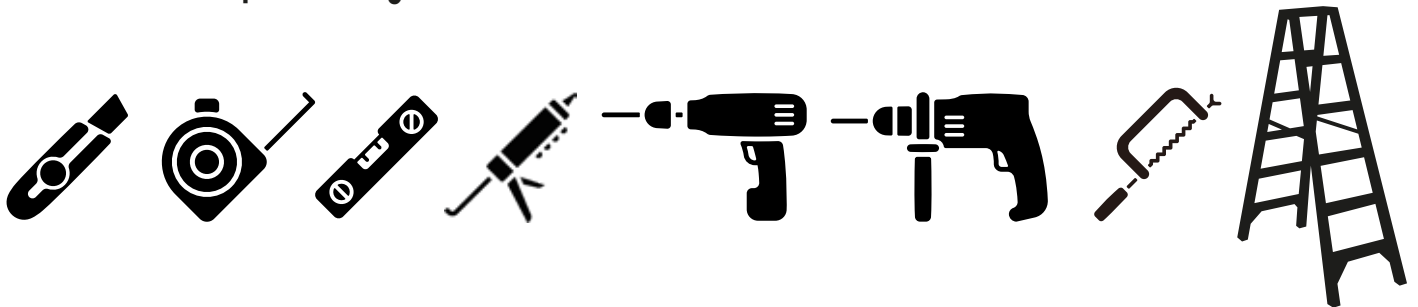

PPE/ PB/ PSA/ EPI:



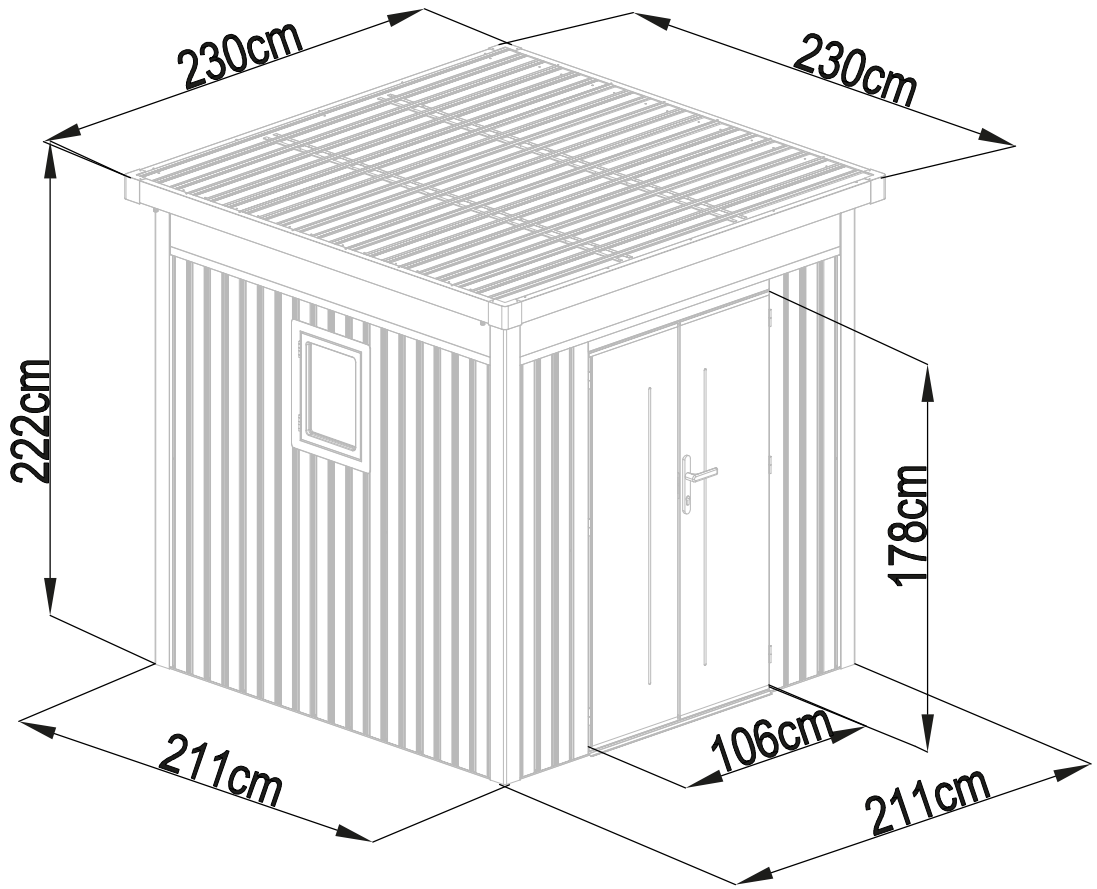

Area of installation requirement:

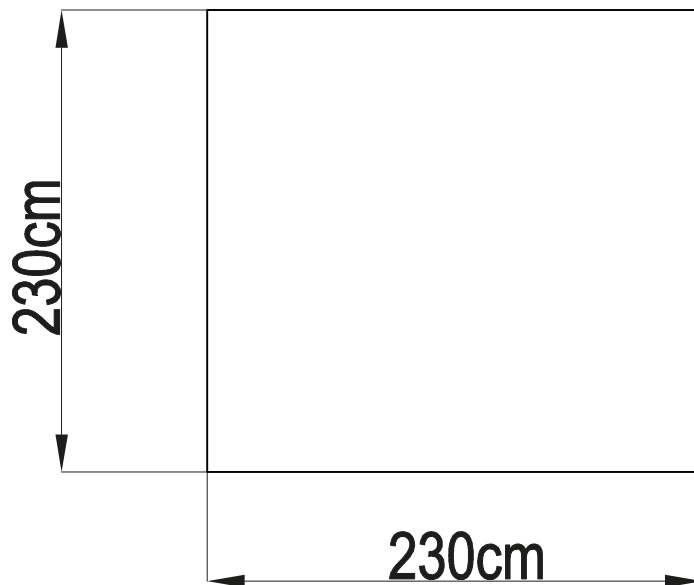



EN: For anchoring instructions, please see steps 42 & 43.



NL: Voor verankeringsinstructies, zie stappen 42 en 43.

DE: Anweisungen zur Verankerung finden Sie in den Schritten 42 und 43.

FR: Pour les instructions d'ancrage, veuillez consulter les étapes 42 et 43.

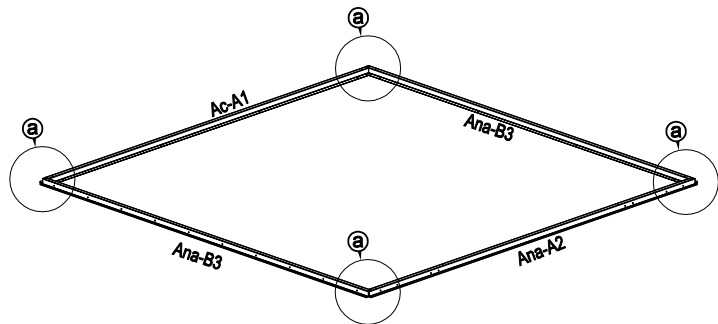
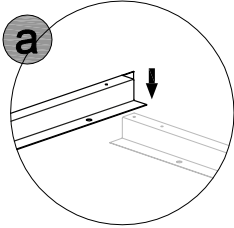
1	 Ac-A1 [x1]	 Ana-A2 [x1]	 Ana-B3 [x2]	
----------	---	--	--	--

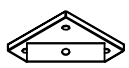

2	 Ab-4 [x4]	 Ana-B41 [x12]	
----------	--	--	--

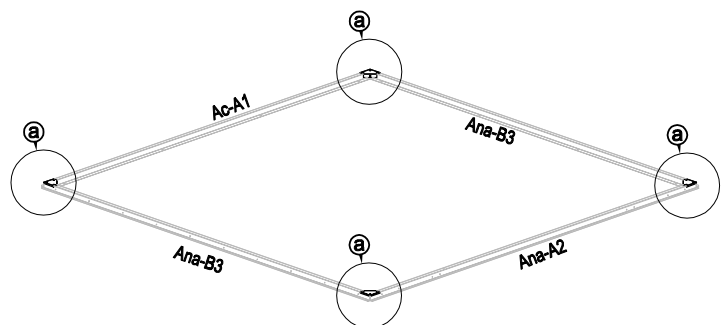
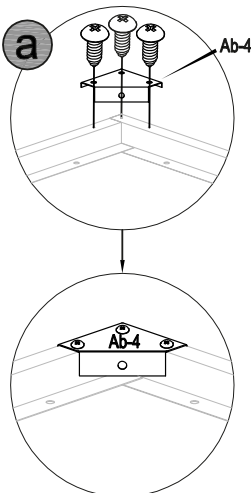

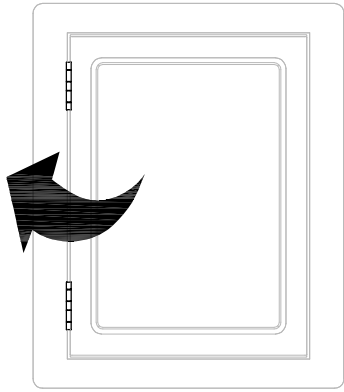



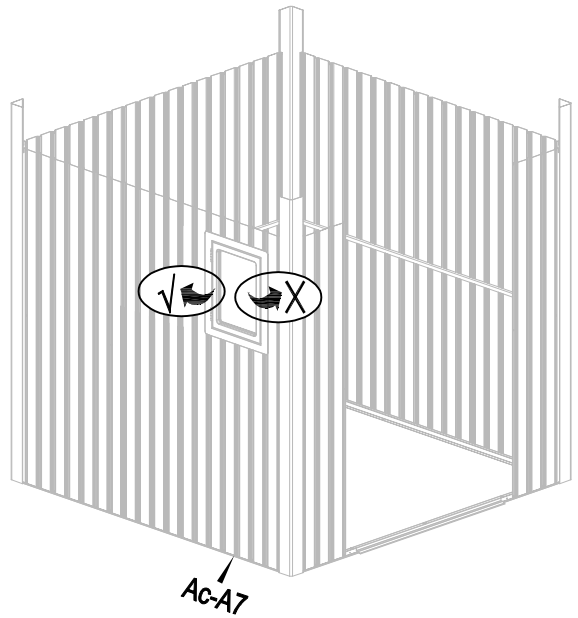
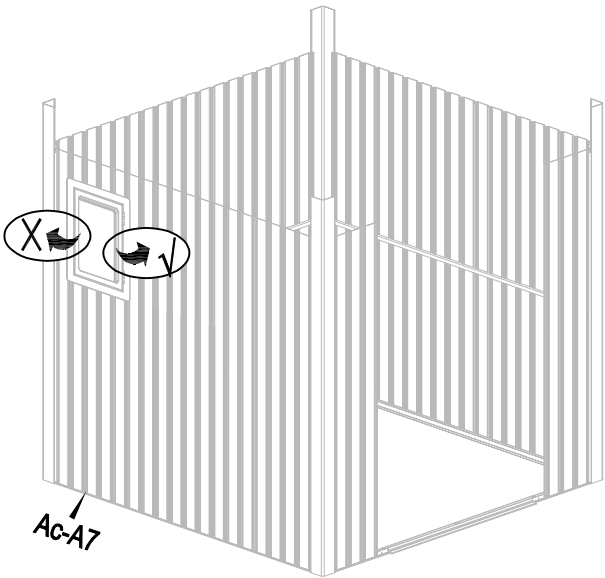
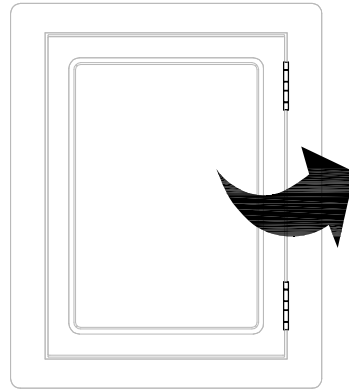

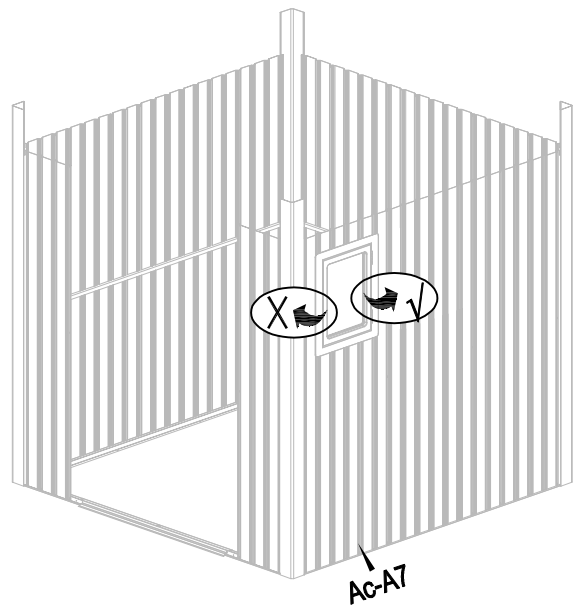
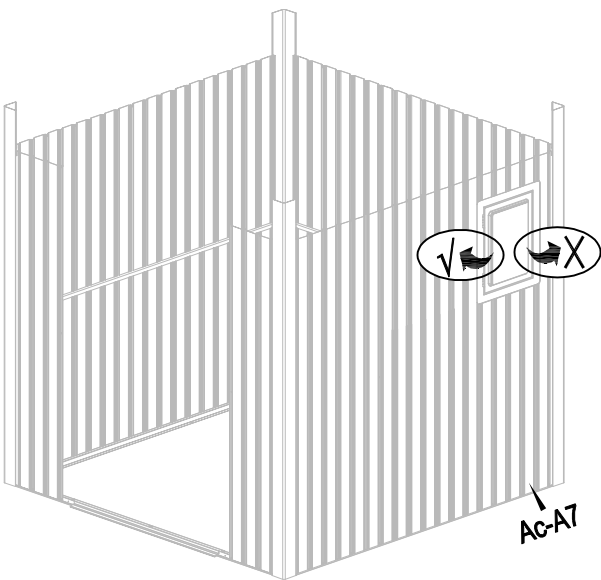
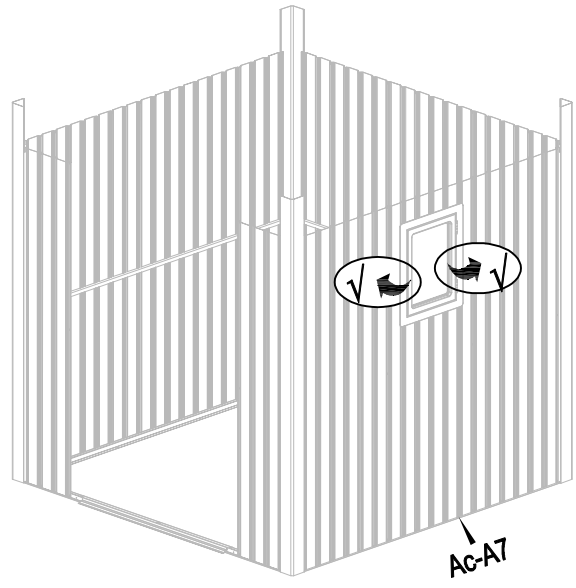
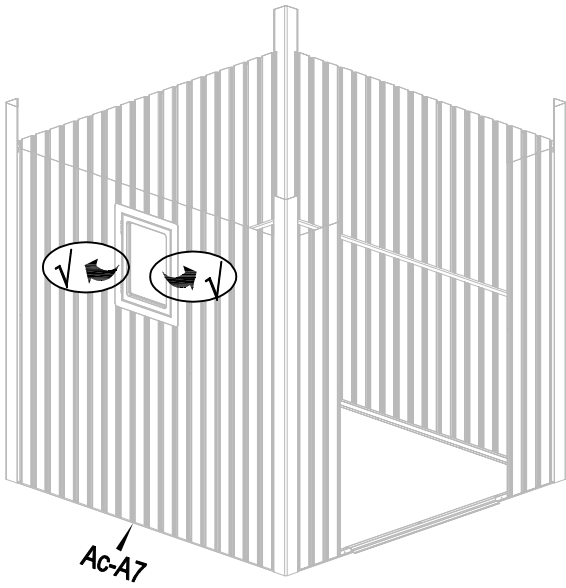



Or



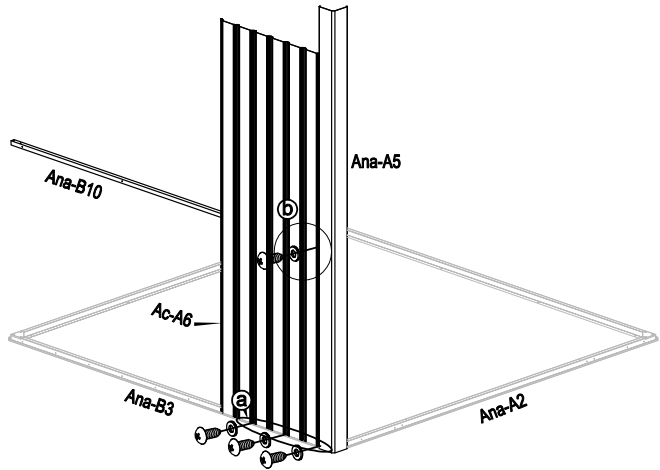
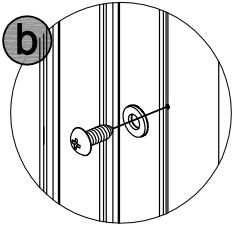
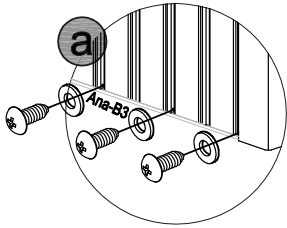
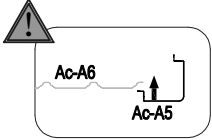





3	 Ac-A6 [x1]	 Ana-A5 [x1]	 Ana-B10 [x1]	 Ana-B41 [x4]	 Ana-B40 [x4]	
----------	---	--	---	--	---	--

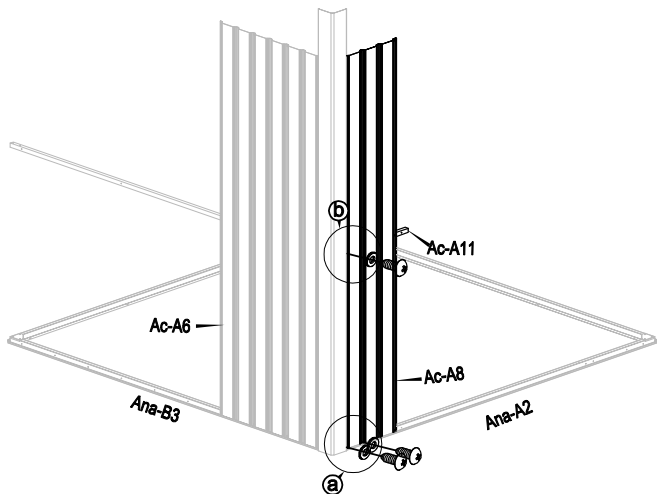
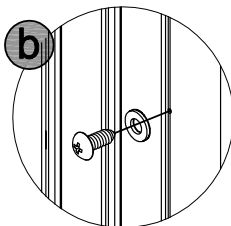
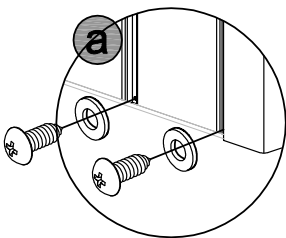





4	 Ac-A8 [x1]	 Ac-A11 [x1]	 Ana-B41 [x3]	 Ana-B40 [x3]	
----------	---	--	---	--	--

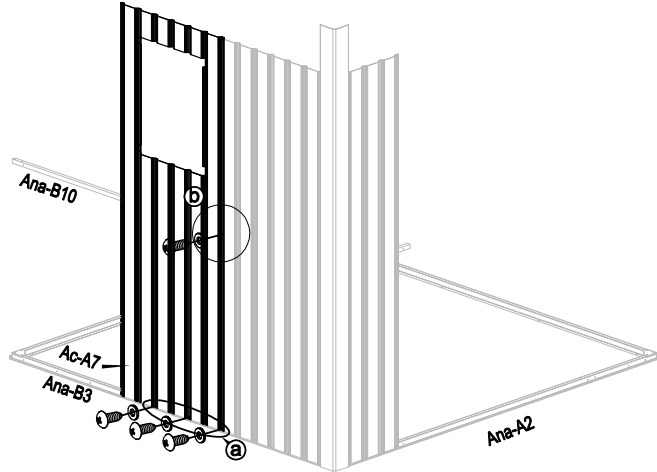
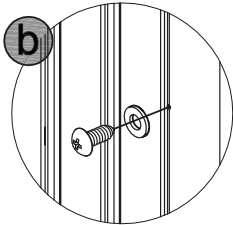
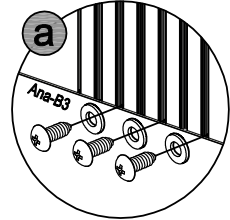





5	 Ac-A7 [x1]	 Ana-B41 [x4]	 Ana-B40 [x4]	
----------	---	---	---	--

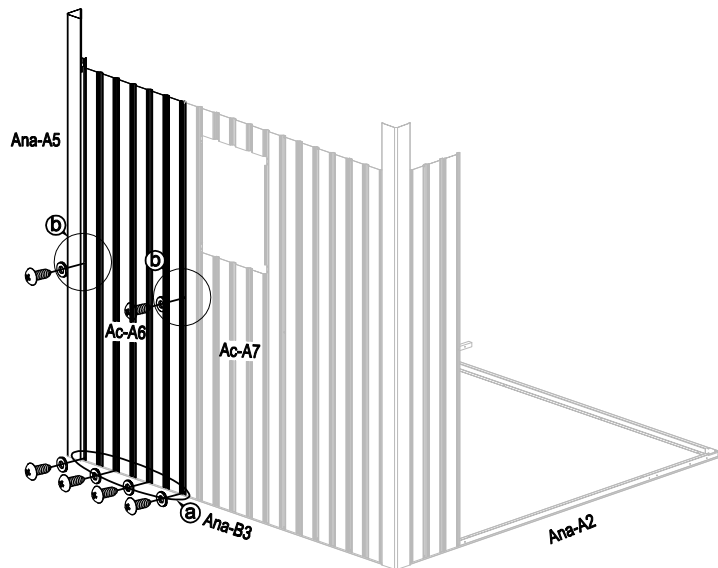
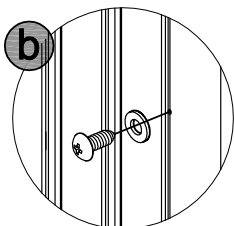
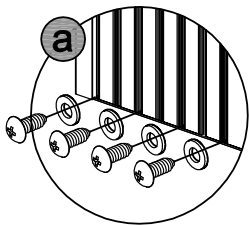



6	 Ac-A6 [x1]	 Ana-A5 [x1]	 Ana-B41 [x6]	 Ana-B40 [x6]	
----------	---	--	---	--	--



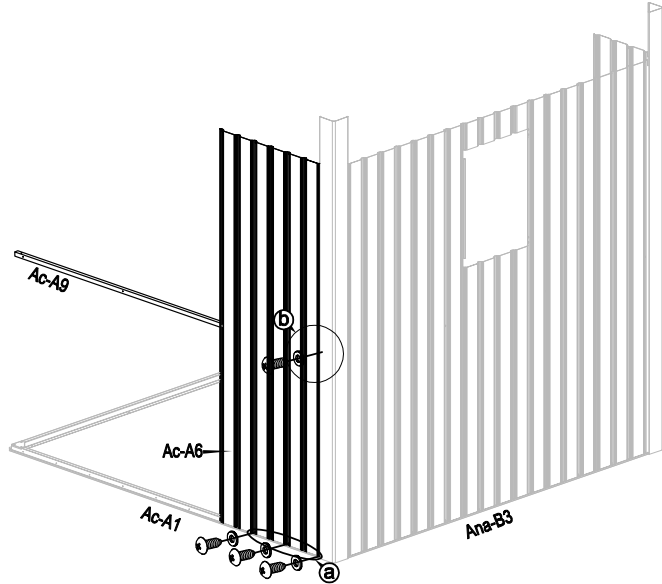
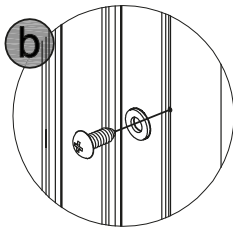
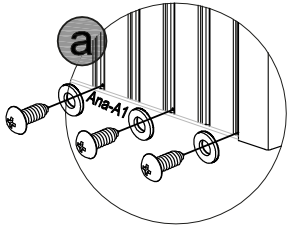



7	 Ac-A6 [x1]	 Ac-A9 [x1]	 Ana-B41 [x4]	 Ana-B40 [x4]	
----------	---	---	---	--	--

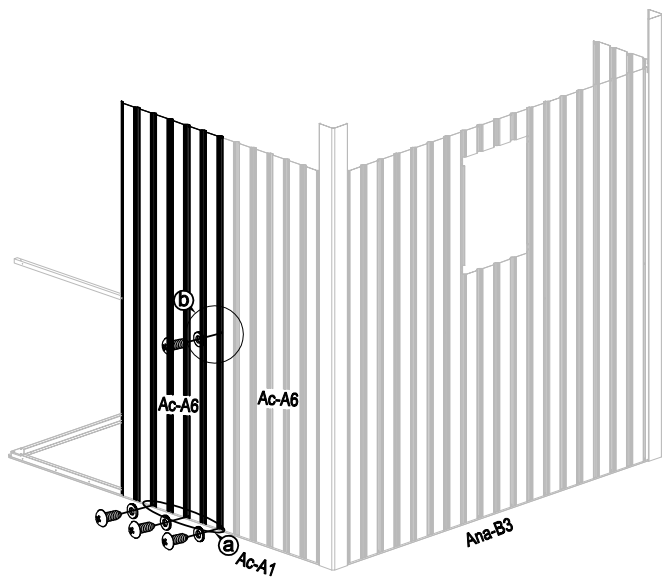
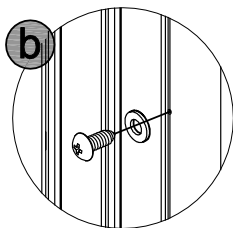
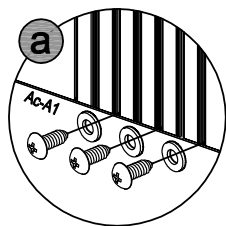





8	 Ac-A6 [x1]	 Ana-B41 [x4]	 Ana-B40 [x4]		
----------	---	---	---	--	--

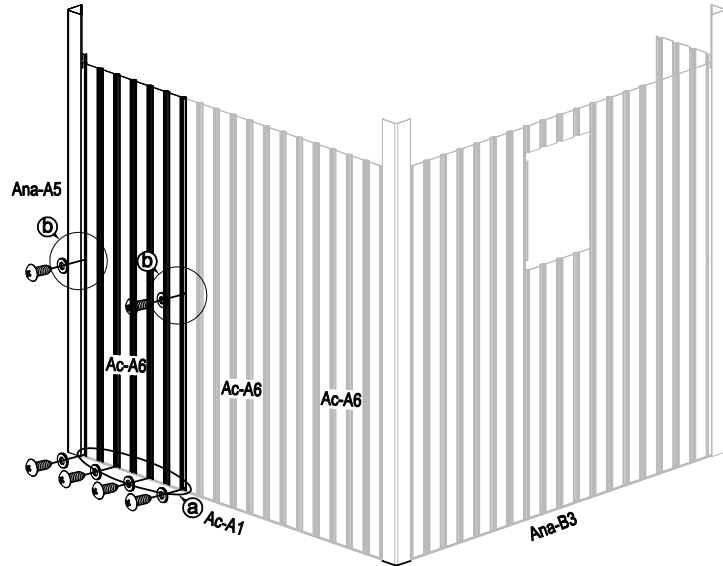
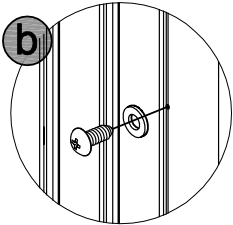
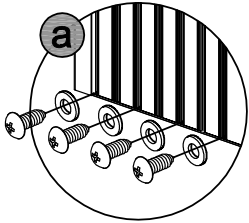



9	 Ac-A6 [x1]	 Ana-A5 [x1]	 Ana-B41 [x6]	 Ana-B40 [x6]	
----------	---	--	---	--	--



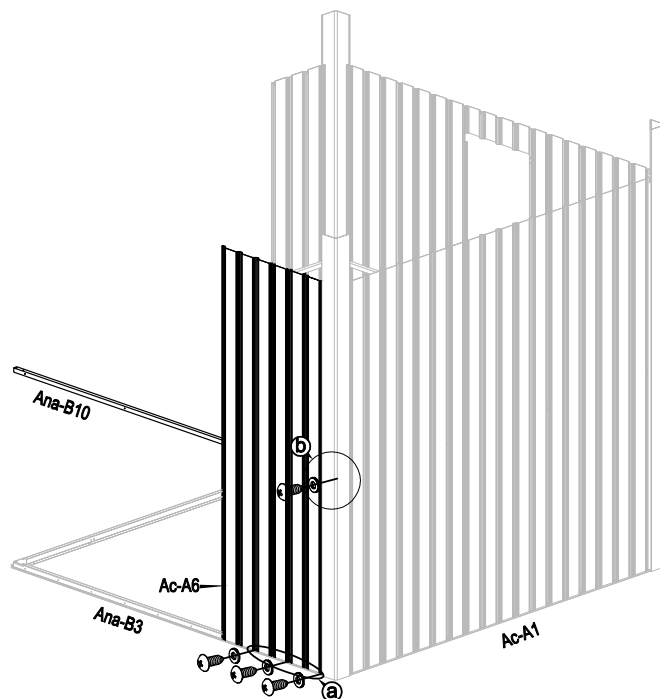
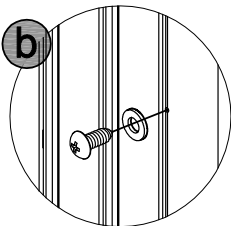
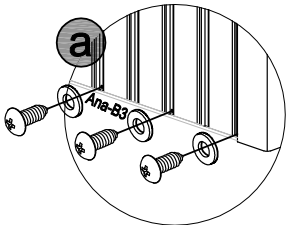



10	 Ac-A6 [x1]	 Ana-B10 [x1]	 Ana-B41 [x4]	 Ana-A40 [x4]	
-----------	---	---	---	--	--

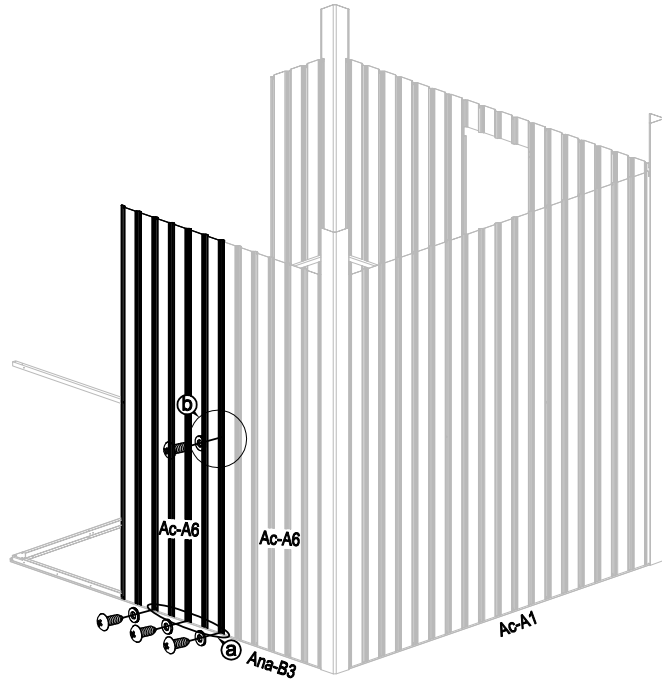
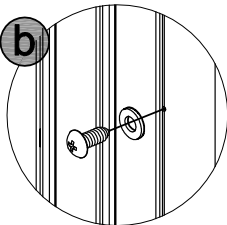
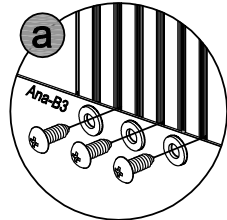





11	 <p>Ac-A6 [x1]</p>	 <p>Ana-B41 [x4]</p>	 <p>Ana-B40 [x4]</p>	
----	---	---	---	--

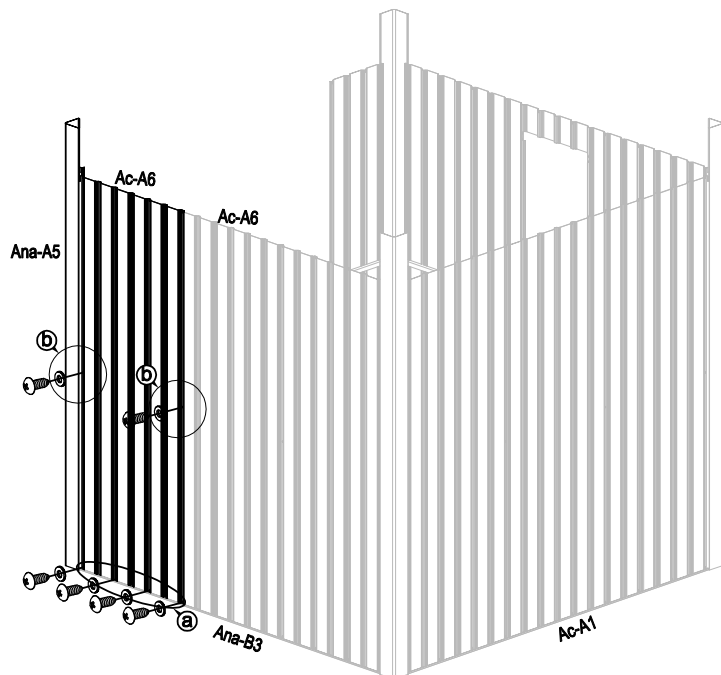
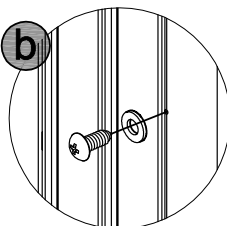
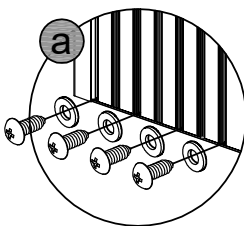



12	 <p>Ac-A6 [x1]</p>	 <p>Ana-A5 [x1]</p>	 <p>Ana-B41 [x6]</p>	 <p>Ana-B40 [x6]</p>	
----	---	--	---	--	--



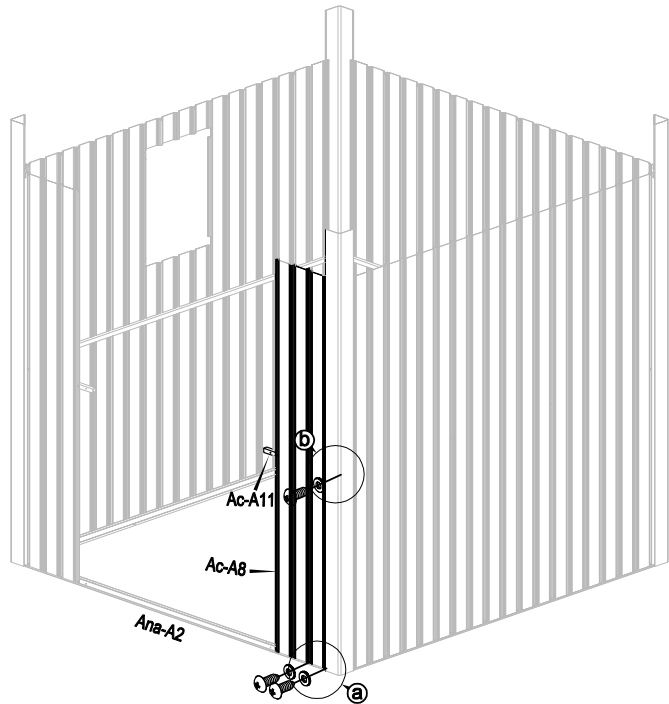
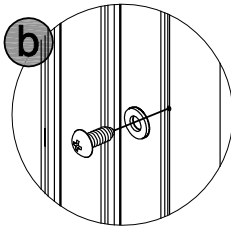
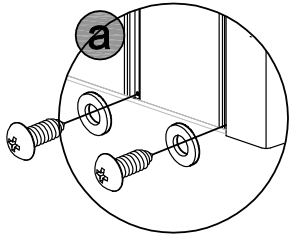



13	 <p>Ac-A8 [x1]</p>	 <p>Ac-A11 [x1]</p>	 <p>Ana-B41 [x3]</p>	 <p>Ana-B40 [x3]</p>	
----	---	--	---	--	--

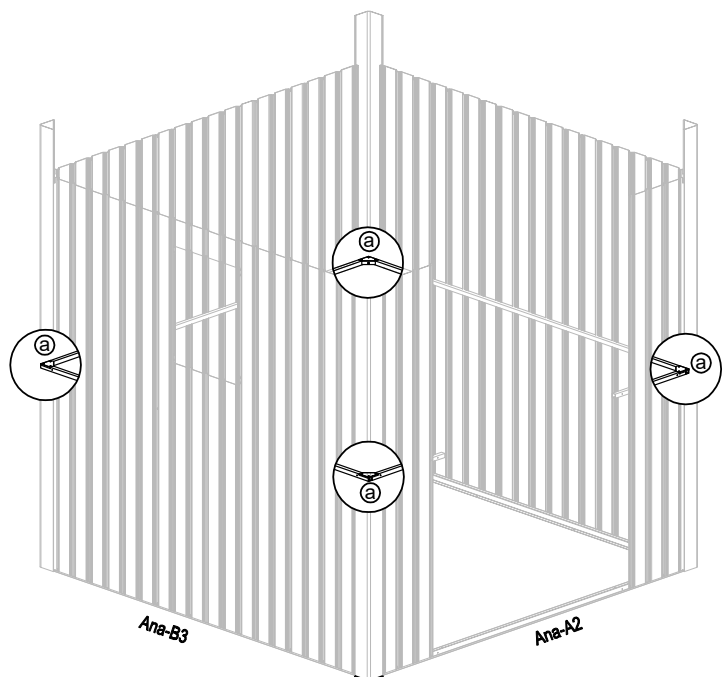
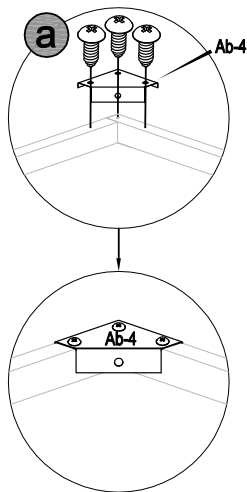





14	 <p>Ab-4 [x4]</p>	 <p>Ana-B41 [x12]</p>	
----	--	--	--

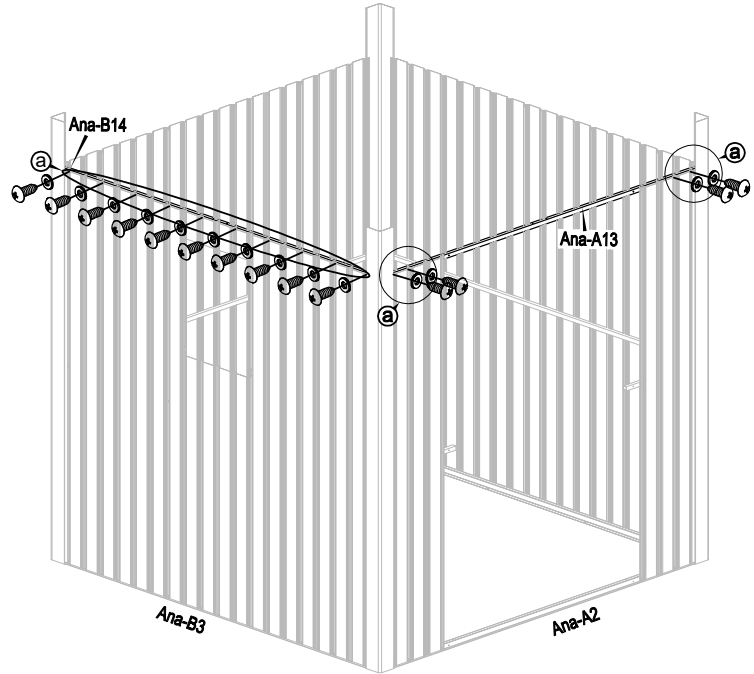
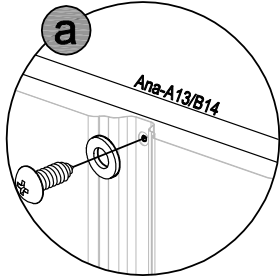

15	 Ana-A13[x1]	 Ana-B14[x1]	 Ana-B41 [x14]	 Ana-B40 [x14]	
-----------	--	--	--	---	--



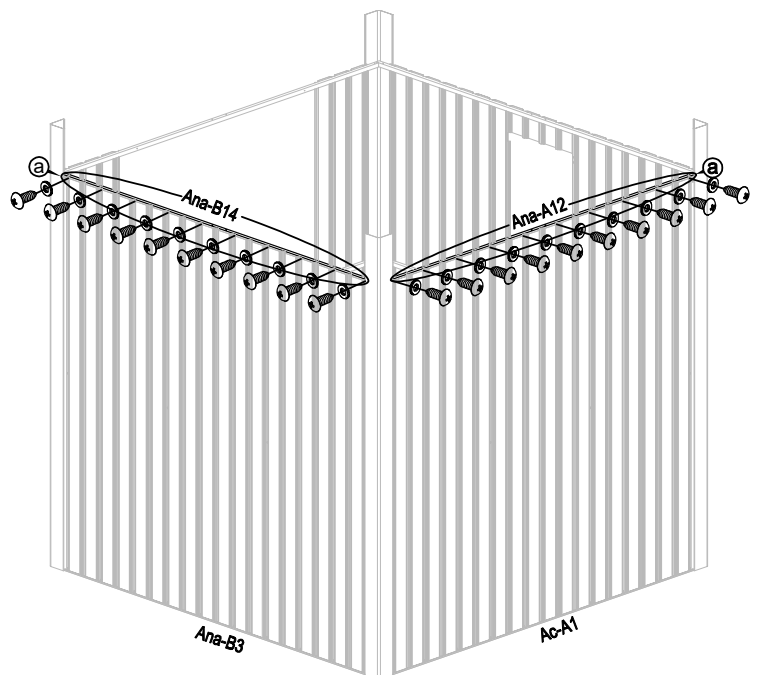
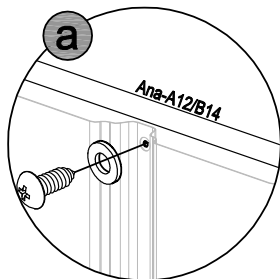

16	 Ana-A12[x1]	 Ana-B14[x1]	 Ana-B41 [x20]	 Ana-B40 [x20]	
-----------	--	--	--	---	--



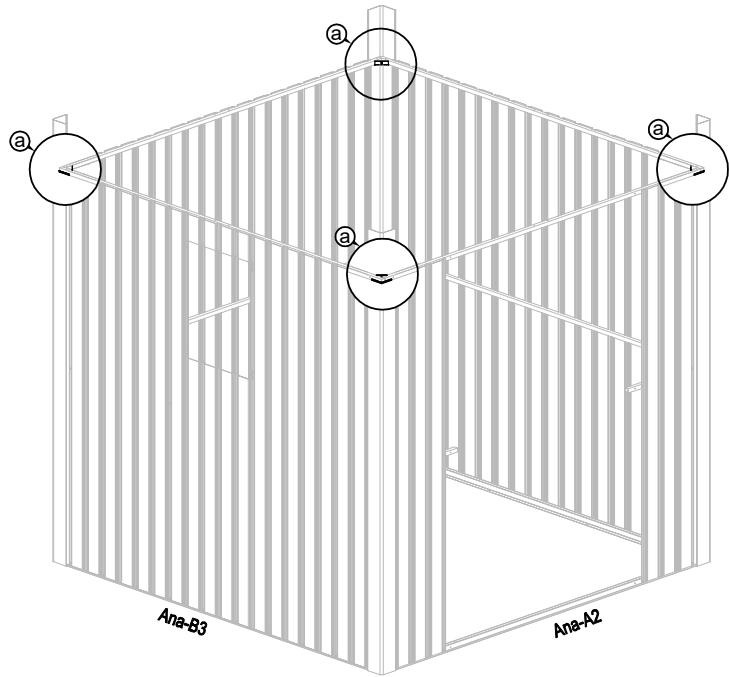
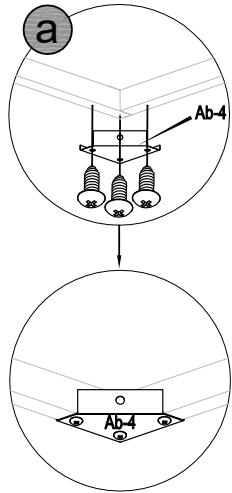

17	 Ab-4 [x4]	 Ana-B41 [x12]	
-----------	--	--	--



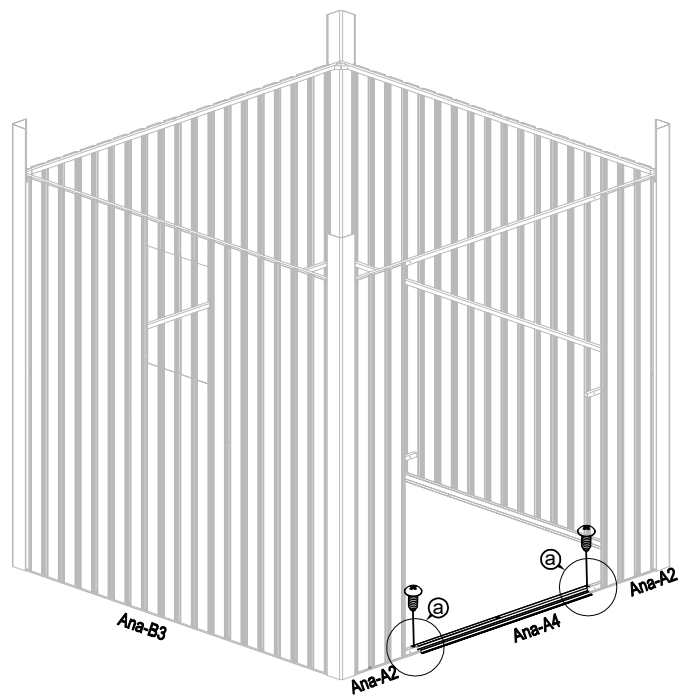
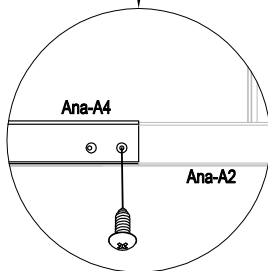
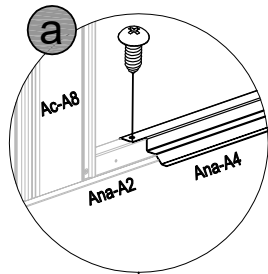
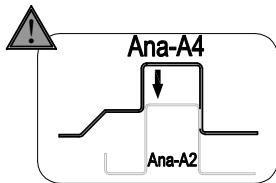



18	 Ana-A4 [x1]	 Ana-B41 [x4]	
-----------	--	---	--

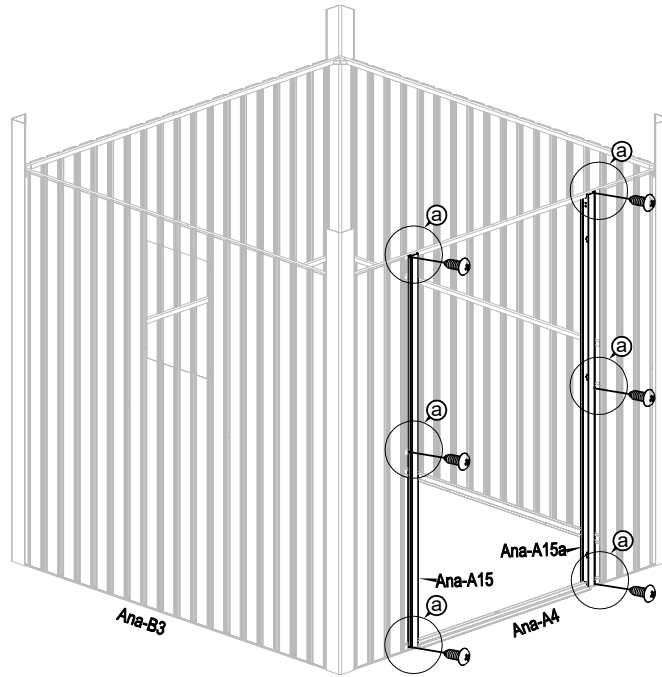
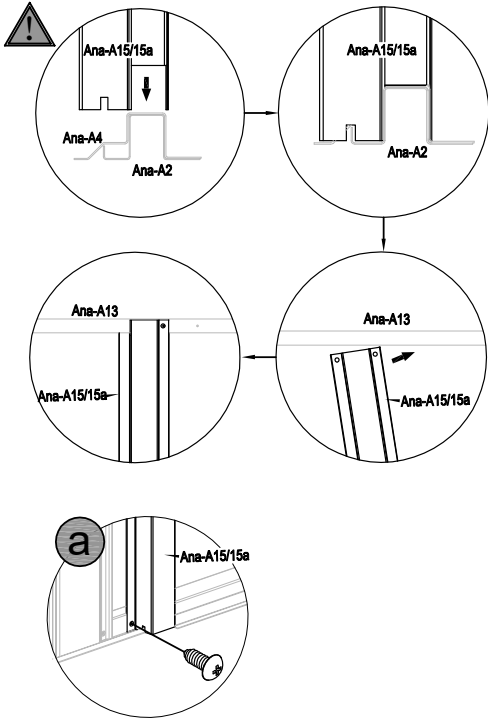

19	 Ana-A15 [x1]	 Ana-A15a [x1]	 Ana-B41 [x6]	
-----------	---	--	---	--



20	 Ana-A16 [x1]	 Ana-A16a [x1]	 Ana-B41 [x10]	 Ana-B40 [x6]
-----------	---	--	--	--

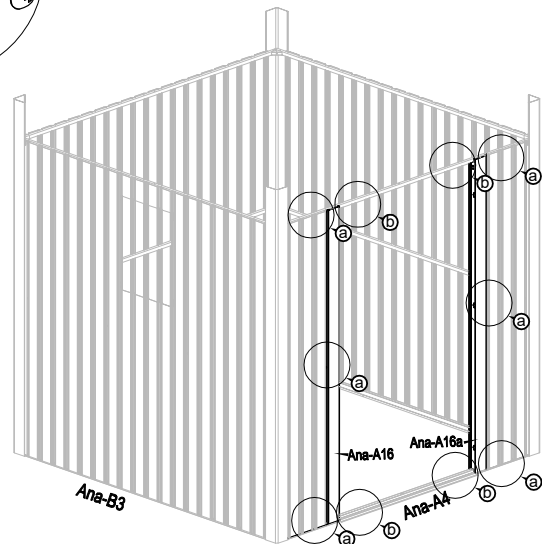
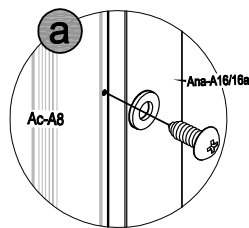
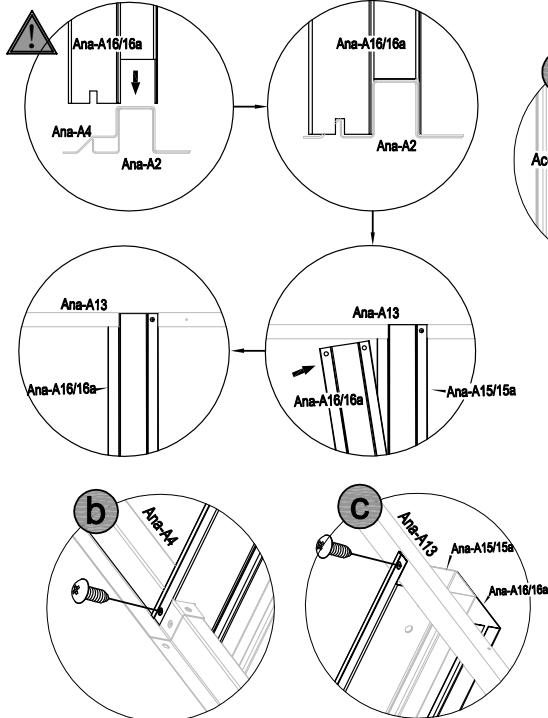

21



Ana-A17 [x1]



Ana-A44 [x4]

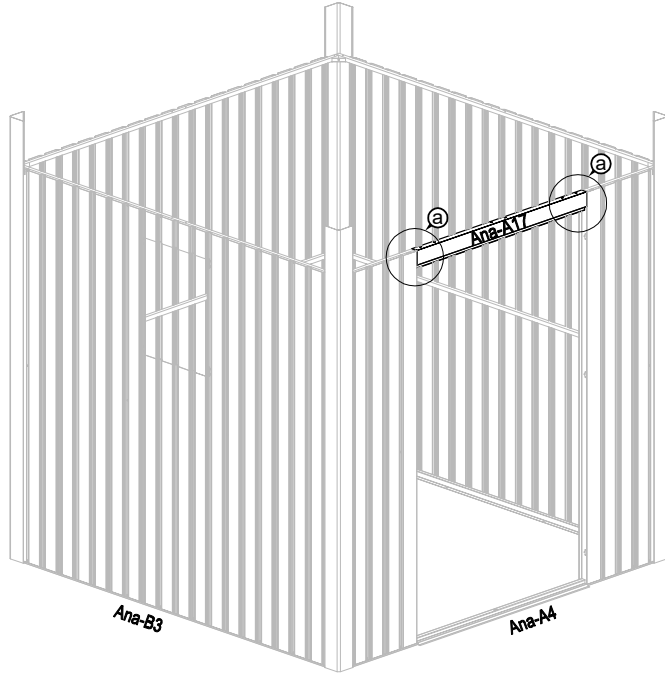
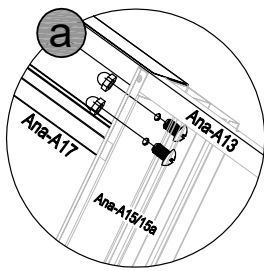
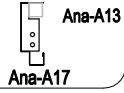



22

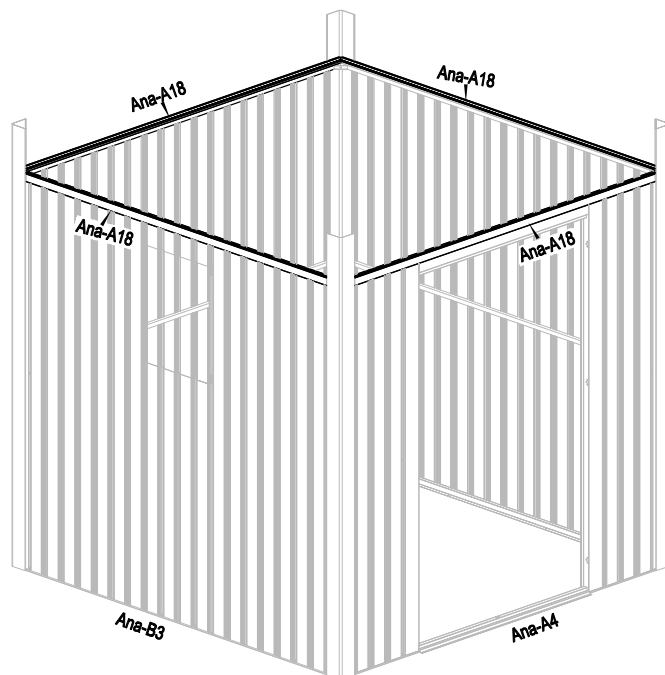
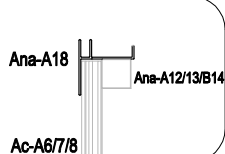
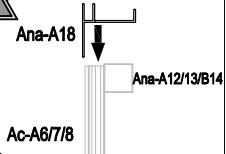

Ana-A18 [x4]

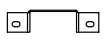

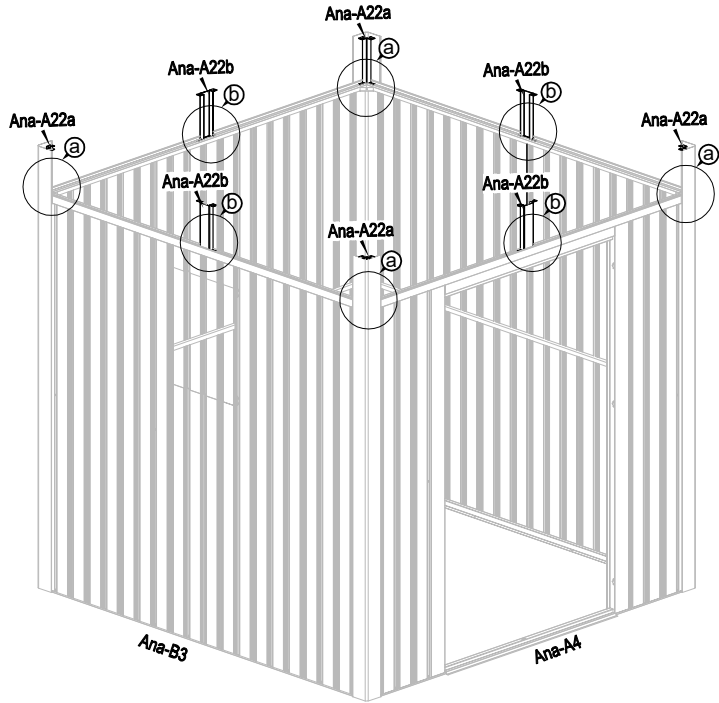
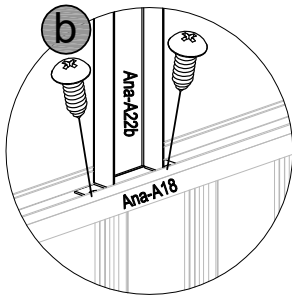
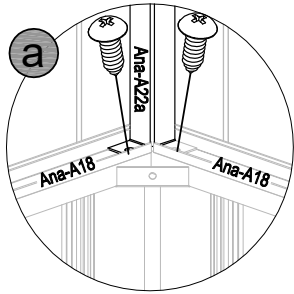

<div style="border: 1px solid black; border-radius: 50%; width: 40px; height: 40px; display: flex; align-items: center; justify-content: center; margin: 0 auto;"> 23 </div>	 Ana-A22b [x4]	 Ana-A22a [x4]	 Ana-B41 [x16]
---	--	--	--

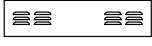

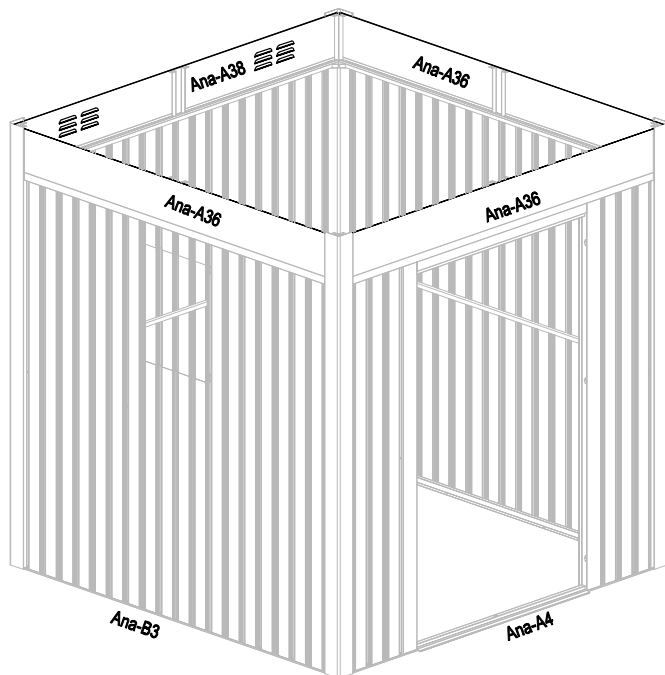
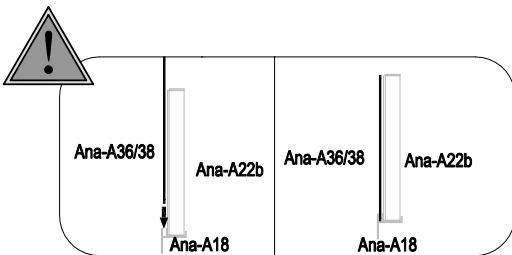
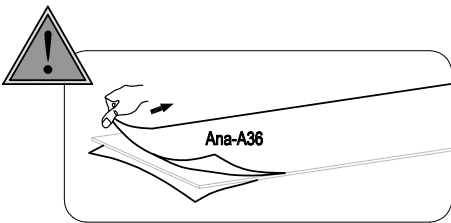



<div style="border: 1px solid black; border-radius: 50%; width: 40px; height: 40px; display: flex; align-items: center; justify-content: center; margin: 0 auto;"> 24 </div>	 Ana-A36 [x3]	 Ana-A38 [x1]
---	---	---

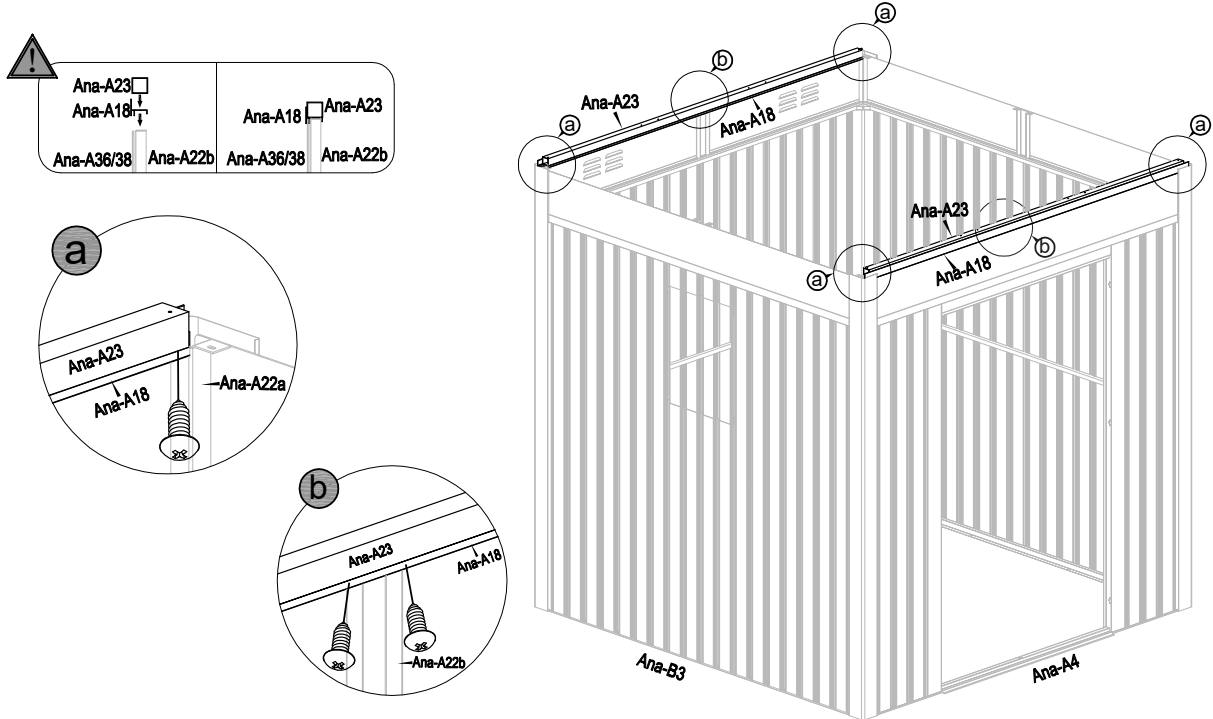

EN: For instructions on placing window rubber, please see step 41.
NL: Voor instructies over het plaatsen van raamrubber, zie stap 41.
DE: Anweisungen zum Anbringen von Fenstergummi finden Sie am Schritt 41.
FR: Pour obtenir des instructions sur la mise en place du caoutchouc de fenêtre, veuillez consulter l'étape 41.

25	 Ana-A23 [x2]	 Ana-A18 [x2]	 Ana-B41 [x8]	
-----------	---	---	---	--



26	 Ana-B27 [x2]	 Ana-A18 [x2]	 Ana-B41 [x8]	
-----------	---	---	---	--

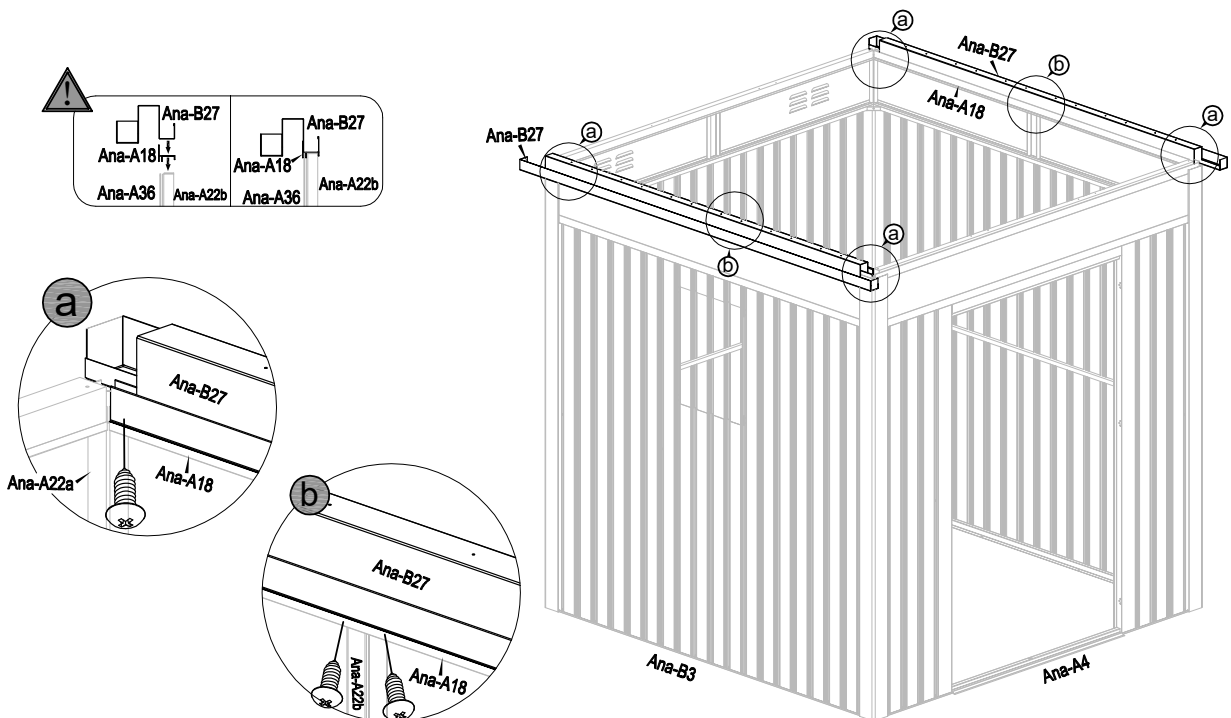

27



Ana-A27 [x2]



Ana-B41 [x4]

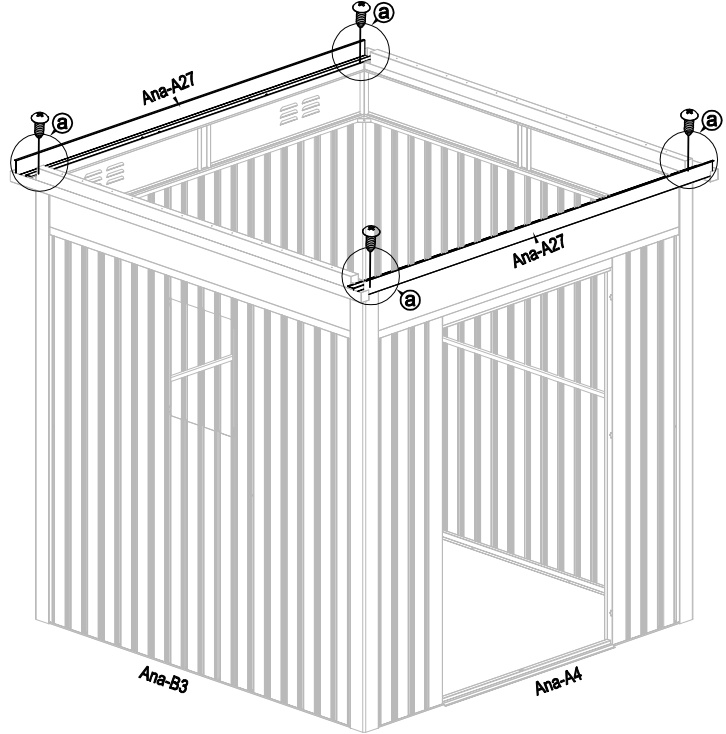
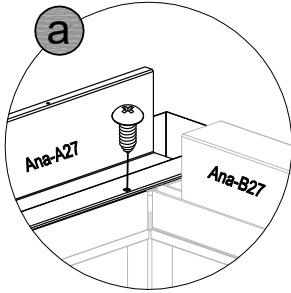

28



Ana-B26 [x2]



Ana-A35 [x8]





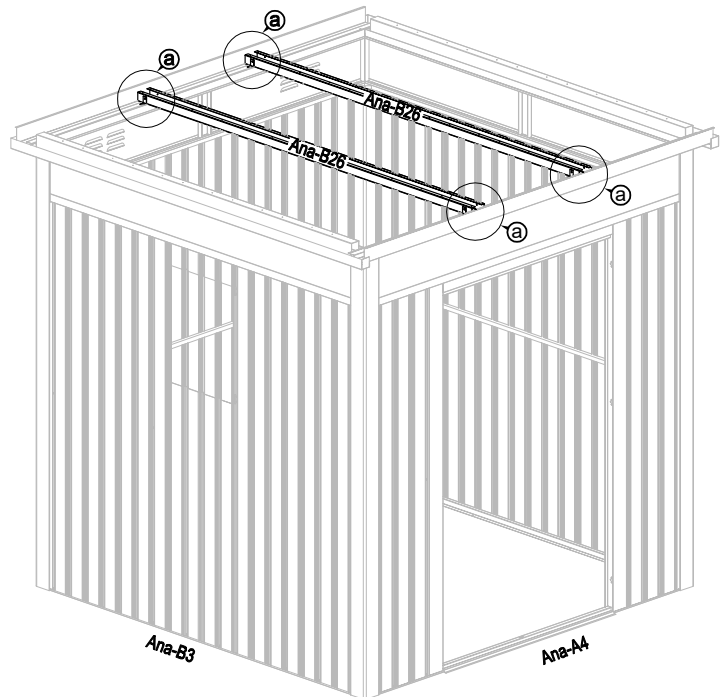
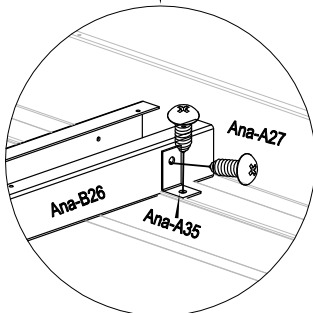
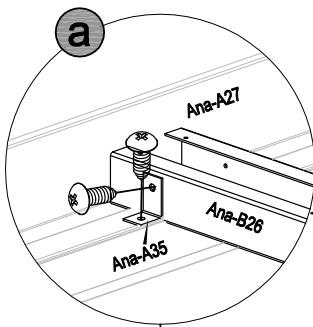

Ana-B41 [x16]



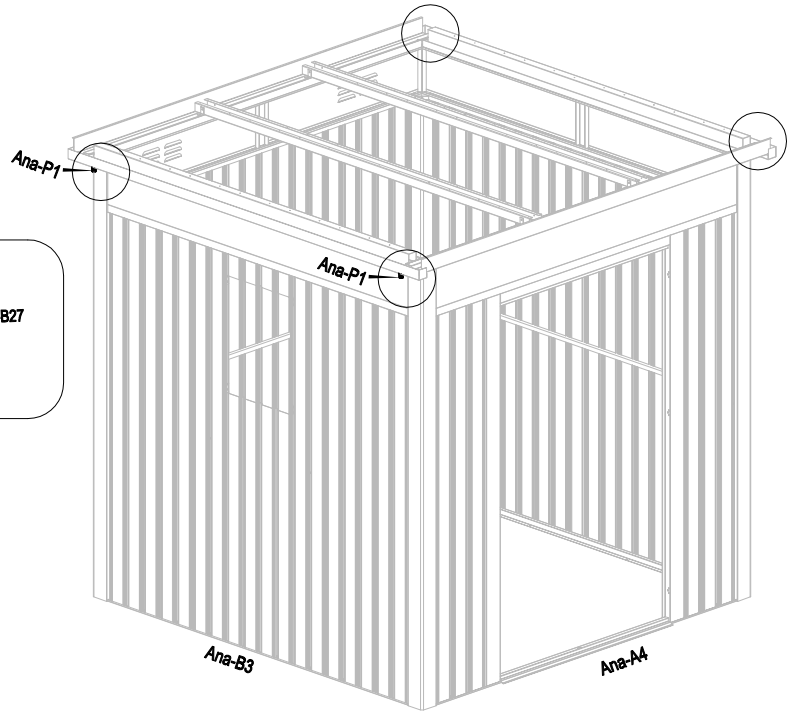

EN: Use a sealant for all surfaces that is also waterproof. (Not included)
NL: Gebruik siliconenkit die toepasbaar is voor alle oppervlakten en waterdicht is. (Niet inbegrepen)
DE: Verwenden Sie einen Silikondichtstoff geeignet für alle Oberflächen und wasserfest ist. (Nicht im Lieferumfang enthalten)
FR: Utilisez un mastic silicone adapté à toutes les surfaces et également imperméable (non inclus).

29	 Ana-P1 [x4]	
----	--	--



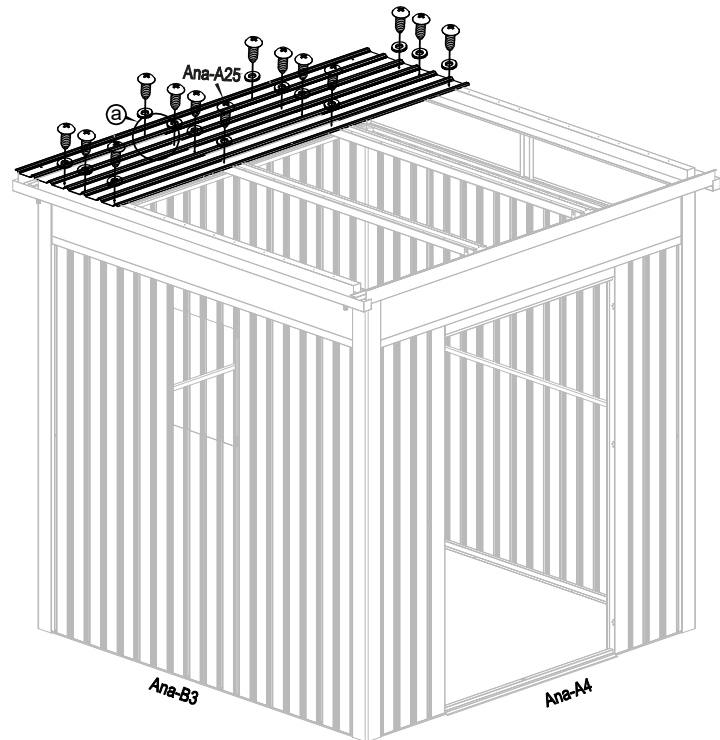
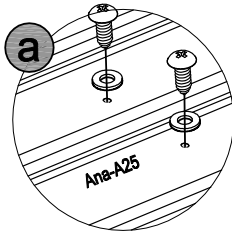

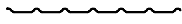
30	 Ana-A25[x1]	 Ana-B41 [x14]	 Ana-B40 [x14]	
----	--	--	--	--



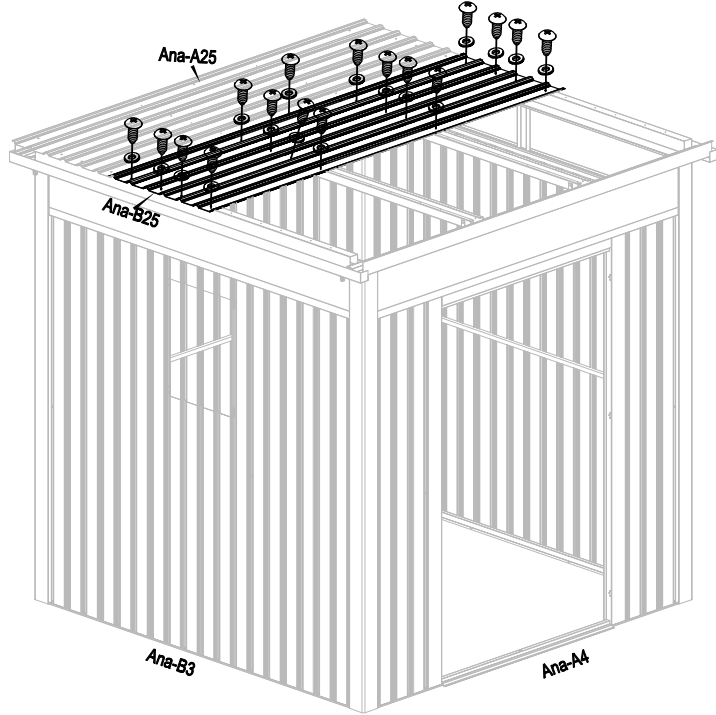
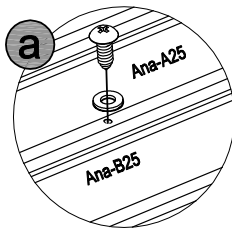
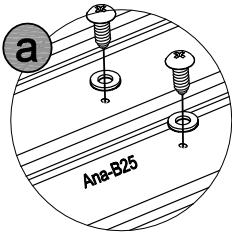
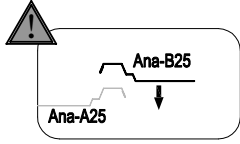

31	 Ana-B25 [x1]	 Ana-B41 [x17]	 Ana-B40 [x17]	
-----------	---	--	--	--



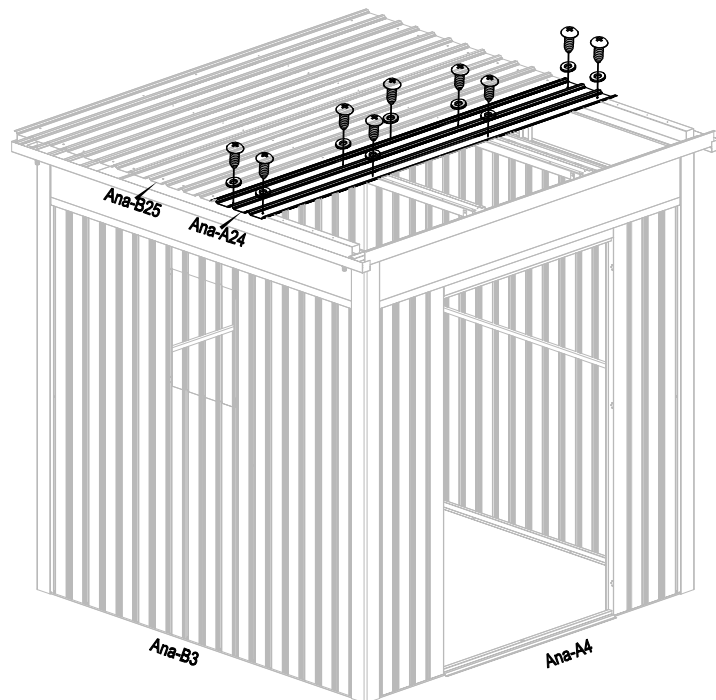
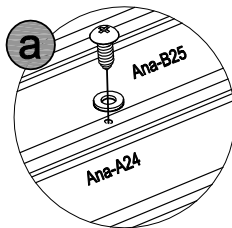
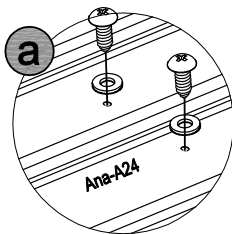
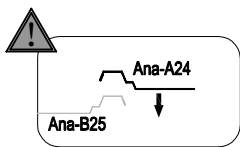

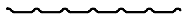

32	 Ana-A24 [x1]	 Ana-B41 [x9]	 Ana-B40 [x9]	
-----------	---	---	---	--

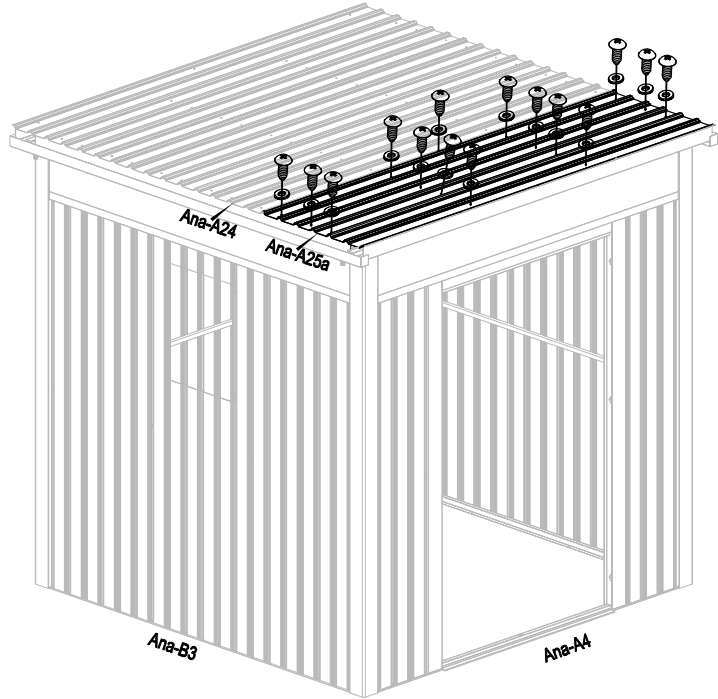
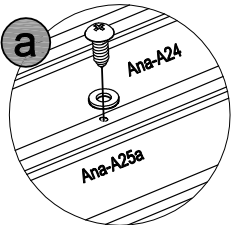
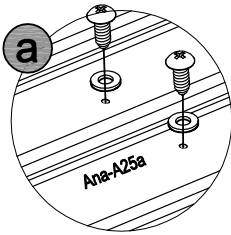
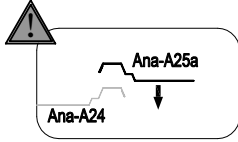

33	 <p>Ana-A25a [x1]</p>	 <p>Ana-B41 [x15]</p>	 <p>Ana-B40 [x15]</p>	
----	--	--	--	--



34	 <p>Ana-A28 [x2]</p>	 <p>Ana-B28 [x2]</p>	 <p>Ana-B41 [x22]</p>	 <p>Ana-B40 [x22]</p>	
----	---	---	--	---	--

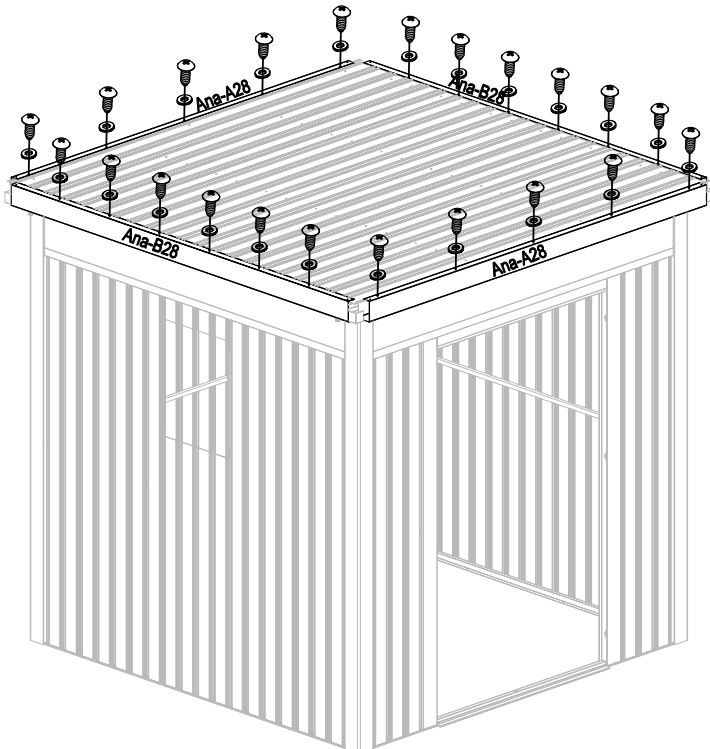
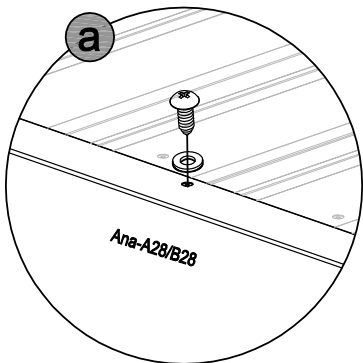

35



Ana-P2 [x4]



Ana-B41 [x16]

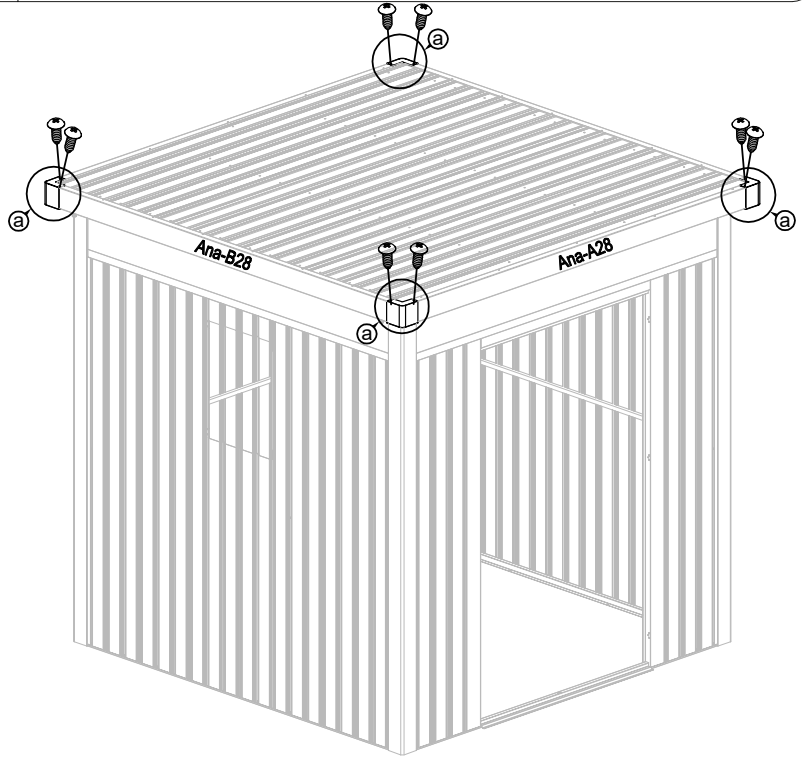
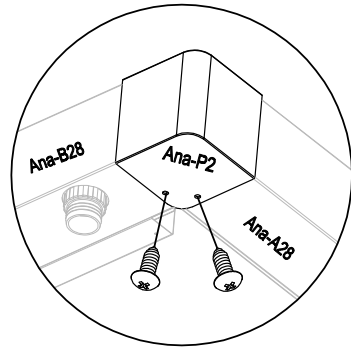
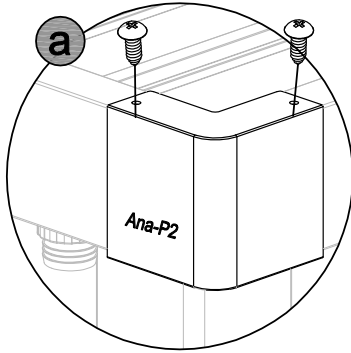

36



Ana-50 [x6]



Ana-A43 [x18]

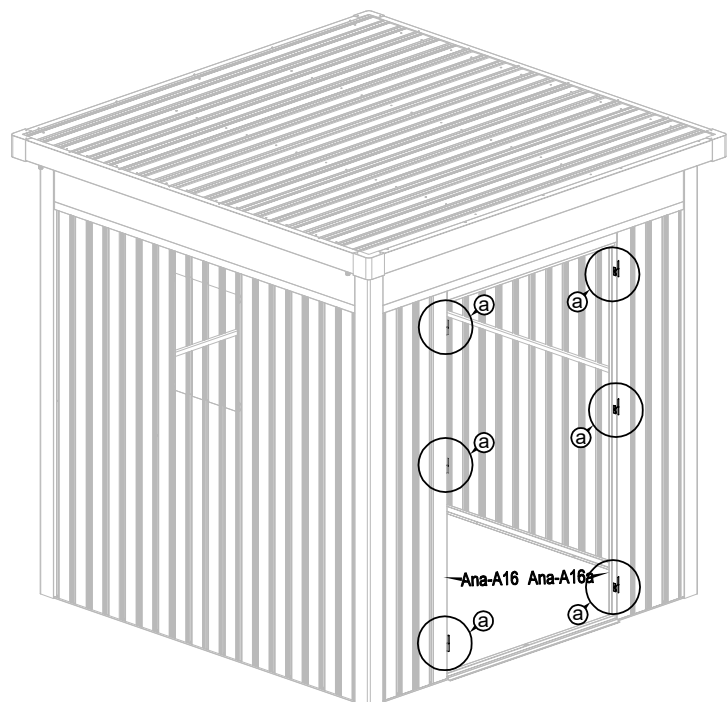
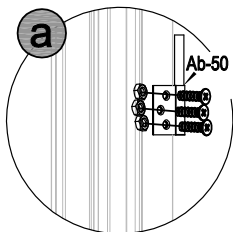

37	Ac-A29[x1]	Ac-A29a[x1]	Ana-54[x1]	Ana-55[x1]	Ana-56[x1]	Ana-57[x1]	Ana-58[x3]	
-----------	------------	-------------	------------	------------	------------	------------	------------	--

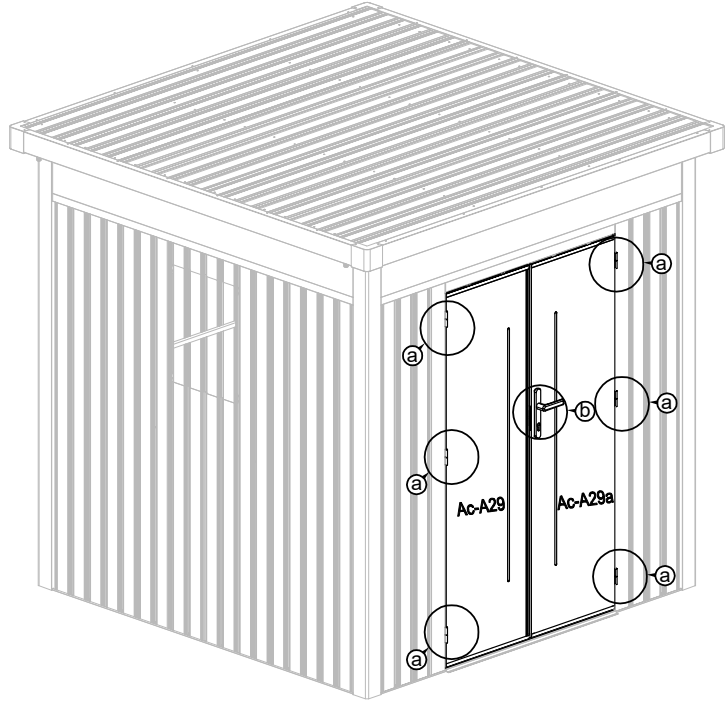
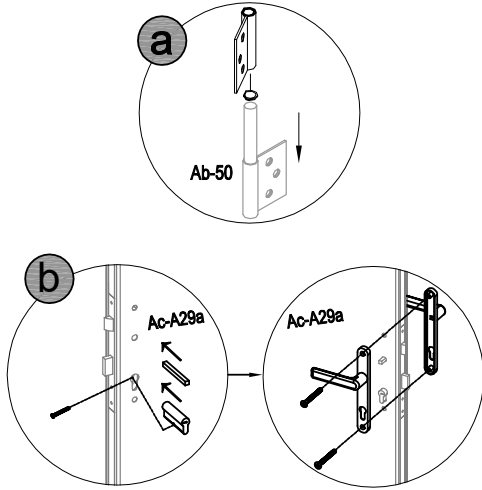

38	Ana-P6 [x1]	Ana-B41 [x4]	
-----------	-------------	--------------	--

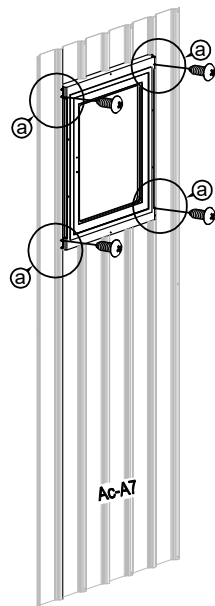
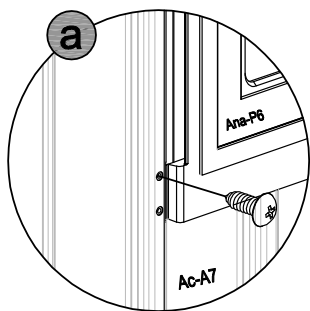
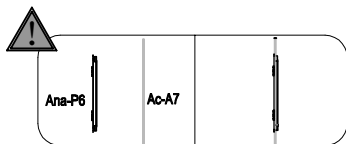

39	 Ana-P7 [x1]	 Ana-B41 [x10]
-----------	--	--

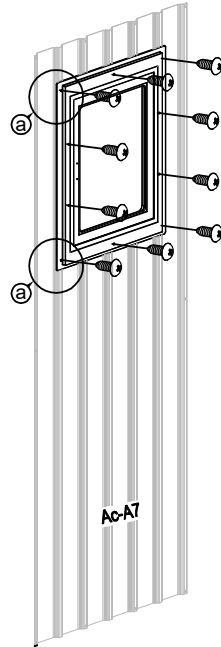
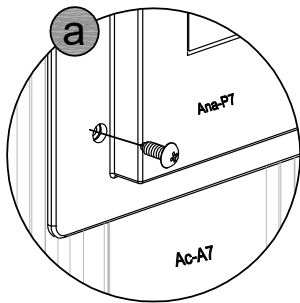
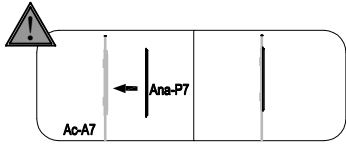

40	 Ana-P6 [x1]	 Ana-A42 [x2]
-----------	--	---

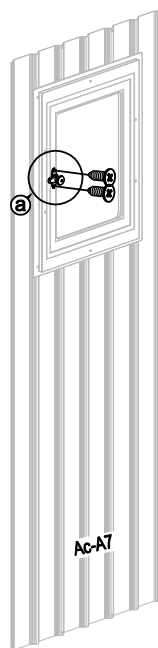
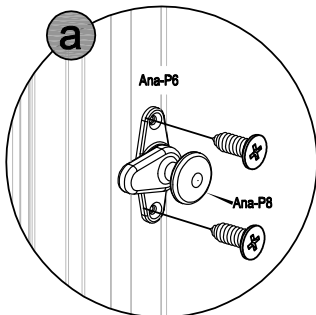

41



Ana-B37 [x16.5M]

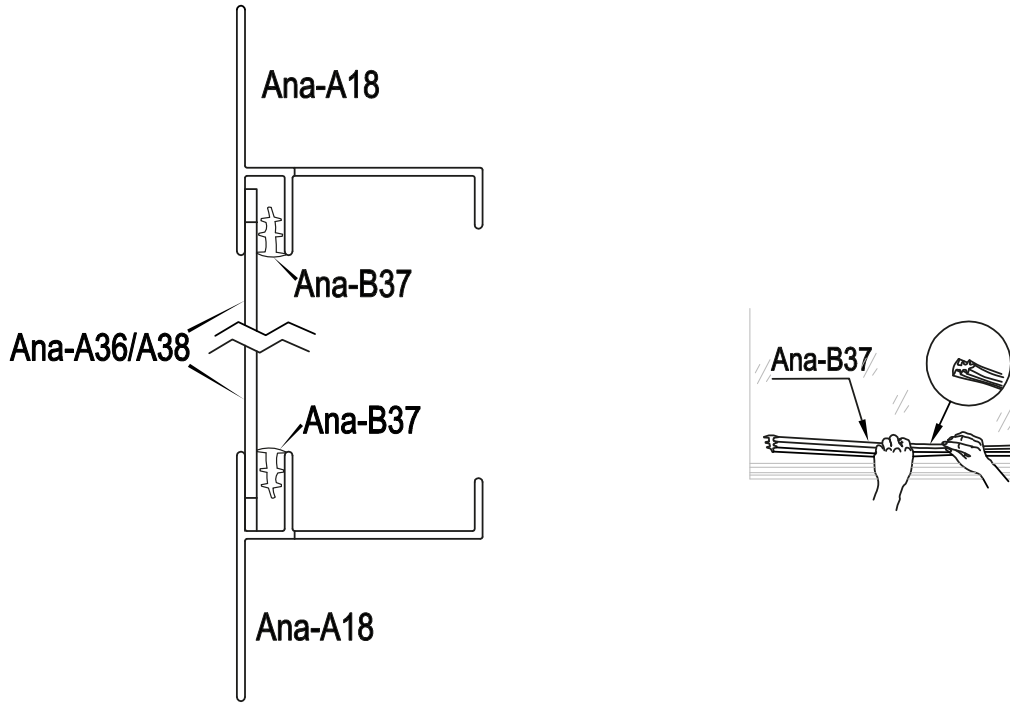

42

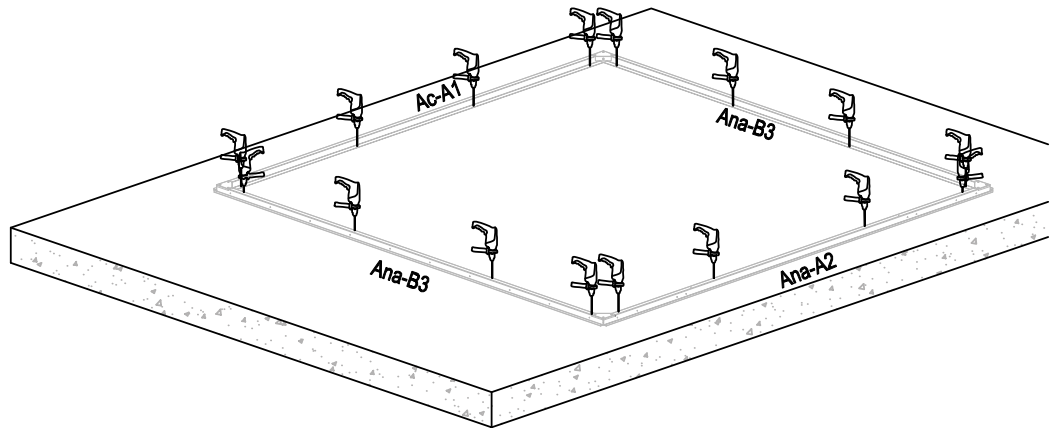
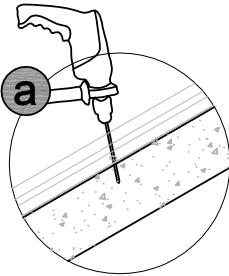
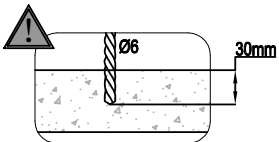
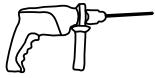

43



Ana-B45 [x16]

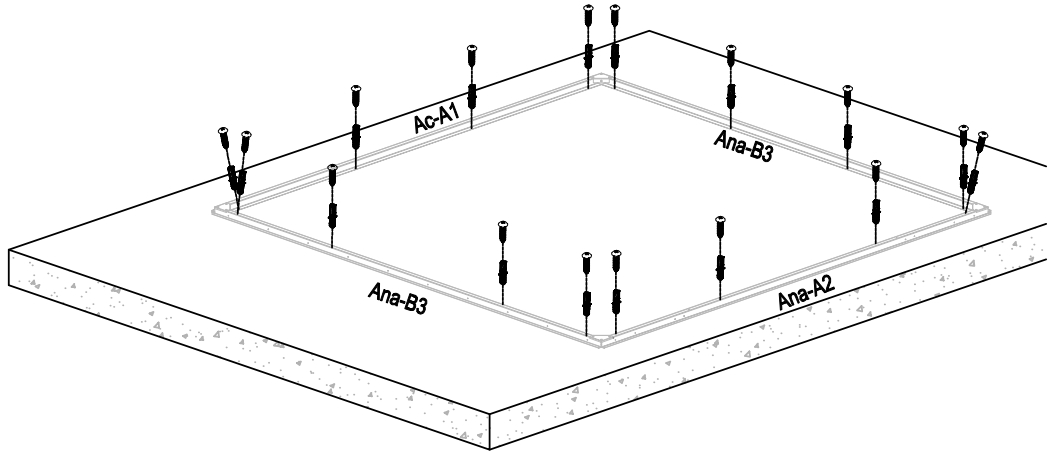
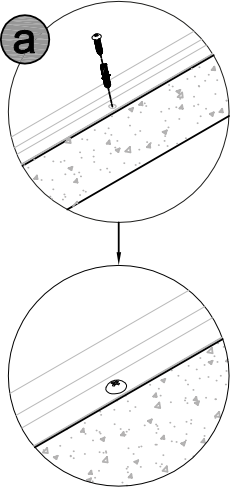



Garden & Storage

Witvrouwenbergweg 13B
5711 CN, Someren
Nederland