



Gardenmeister

Handleiding

Royal Garden 100-300-500-700-900

GM800500/GM805870/GM805880/GM805885/GM805888

INHOUD

1. Montageadvies	Pagina 1
2. Producteigenschappen	Pagina 1-3
3. Onderdelenlijst	Pagina 4-10
4. Basismontage	Pagina 11-14
5. Deurmontage	Pagina 15-17
6. Montage dakventilatie	Pagina 18-19
7. Frame- en paneelmontage	Pagina 20 - 34

Montage- en onderhoudsadvies

1. Om veiligheidsredenen raden wij ten zeerste aan dat dit product door ten minste twee personen wordt gemonteerd.
2. Sommige onderdelen hebben scherpe metalen randen. Wees voorzichtig bij het hanteren van metalen onderdelen. Draag tijdens de montage handschoenen, schoenen en een veiligheidsbril.
3. Leg alle onderdelen op een zacht tapijt of deken om krassen of beschadigingen te voorkomen.
4. Klim of sta NIET op het dak. Zware voorwerpen mogen niet tegen de kas worden geleund.
5. Houd het dak en de goot vrij van sneeuw, vuil en bladeren. Als er zich sneeuw op het dak ophoopt, kan er schade ontstaan het product.
6. In tegenstelling tot staal zal een kras op de verfafwerking het aluminium eronder niet beschadigen.
7. Als uw product moet worden gereinigd, gebruik dan een mild schoonmaakmiddel en spoel af met koud, schoon water. Gebruik geen aceton, schurende schoonmaakmiddelen of sterke schoonmaakmiddelen om de panelen schoon te maken.

Gratis aangeboden hulpmiddelen:

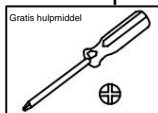
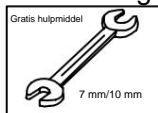

Extra gereedschap voor montage (niet meegeleverd):

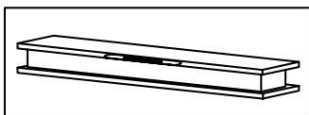
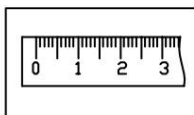
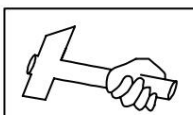

Minimaal 2 personen:



Functies en kenmerken:

1. Vergeleken met traditionele kassen kent dit opwindende product veel belangrijke verbeteringen. Het aluminium frame met holle kokerprofiel is veel sterker dan andere kassen en kan veel grotere druk weerstaan.

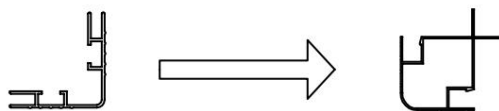

2. Eenvoudige en snelle montage.

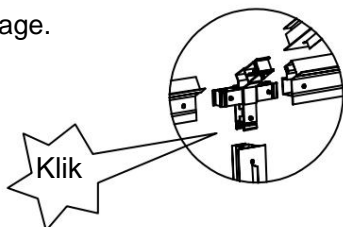

3. De sterke tweedelige dakrandbalk is voorzien van een integrale goot. Ook worden er standaard regenpijpen meegeleverd, zodat u regenwater kunt opvangen.

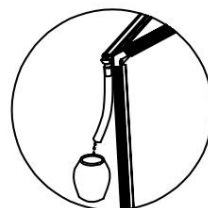

4. De kas kan op elk moment eenvoudig worden uitgebreid in secties van 2 meter, zoals aangegeven in de tabel op de voorpagina.
5. Basisankerbeugels worden standaard meegeleverd met spreidbouten om een veilige bevestiging in beton of bestrating te garanderen. Als alternatief kunt u de beugels gebruiken om deze met houtschroeven (niet meegeleverd) in een houten basis te bevestigen.

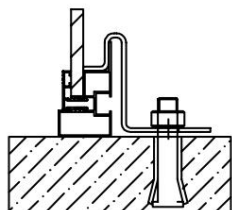

Expansiebout in beton

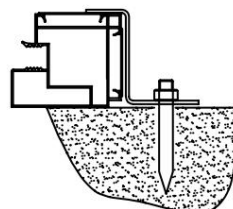

Stalen staaf/gazonland

6. Bij de dakramen worden handmatige raamkrukken standaard meegeleverd. Indien gewenst zijn automatische dakventilatie-openers als voordelige optie leverbaar.

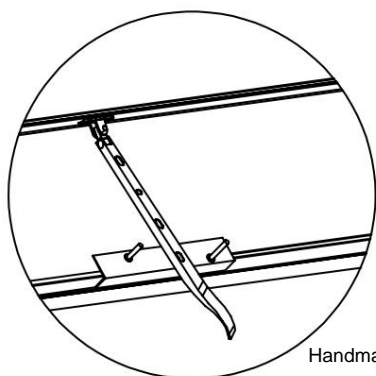

Handmatige opener

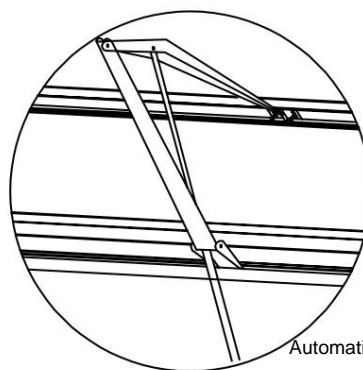

Automatische opener



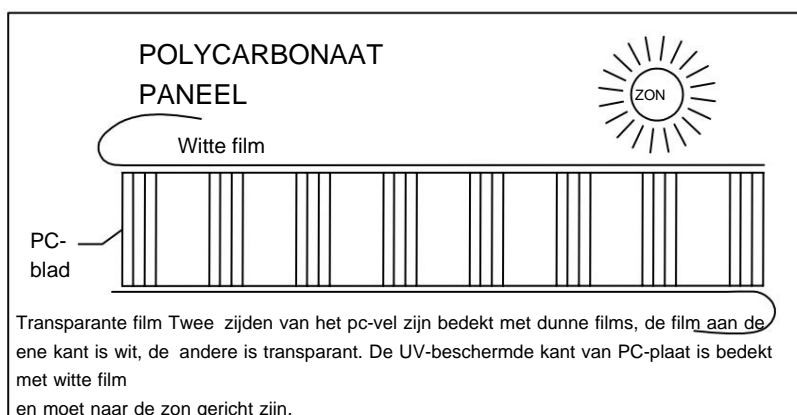



7. Elk polycarbonaatpaneel wordt geleverd met UV-beschermde eigenschappen. Zorg ervoor dat de witte film naar buiten, richting de zon, gericht is. Verwijder beide films voordat u de panelen installeert.











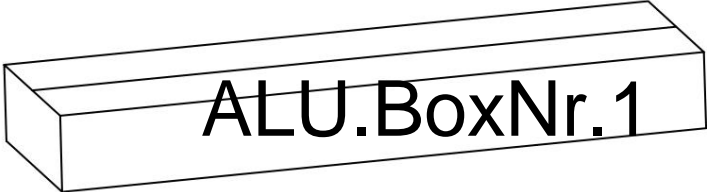













BELANGRIJK:

*Rubberachtige afdichtingen zijn ALLEEN voorzien voor glasbeglazing.









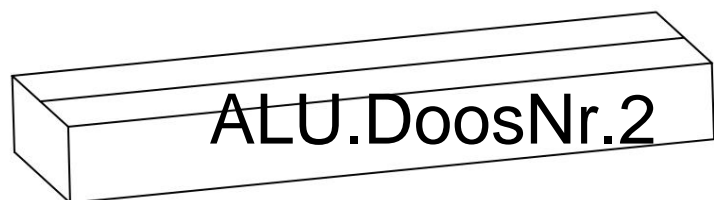

































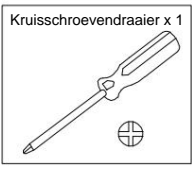



	ONDERDEELNR	AANTAL
1	 L02B	4
2	 L02D	1
3	 L05C	4
4	 L06C	1
5	 L07C	2
6	 L08C	2
7	 L09C	2





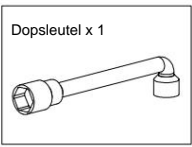



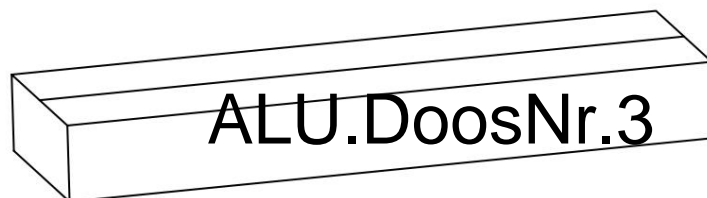

	ONDERDEELNR	AANTAL
1		L01B 2
		L01C 2
2		L03B 1
3		L03C 1
		L03D 1
		L03E 1
		L03F 1
4		L05B 2
5		L08B 2
6		L16A 1
		L16B 1
		L16C 1
		L16D 1
7		L16E 1
		L16F 1
		L16G 1
		L16H 1
8		L17 1
		L18A 2
9		L18B 1
		L18C 1
10		L23A 4



	ONDERDEELNR	AANTAL		ONDERDEELNR	AANTAL		ONDERDEELNR	AANTAL	
1		L01A	2		A52	2		J42	4
		L01D	1		A53	2		J52	2
		L01E	1		A54	4		J53R	2
2		L02A	4		A55	6		J53L	2
3		L02C	1		D77	12		J54	4
4		L04A	6		D07	12		J92	4
5		L04B	6		A01	4		J93	4
6		L05A	2		A03	2		J94	4
7		L08A	4		A04	2		J95	4
8		L10	2		H63	9			
		L15A	2		S05	M6X12	163		
9		L19A	4		M03	M6	163		Kruisschroevendraaier x 1
		L20	2		S28	M4X10	8		
		L21	2		M02	M4	8		
10		L30	4		S26	M5X12	5		Steeksleutel x 1
					S27	M5X12	36		
					S08	M8X60	12		
					Z08	M4.2X16	56		Dopsleutel x 1
					Z02	4X14D	24		
					Z17	M5X12	18		







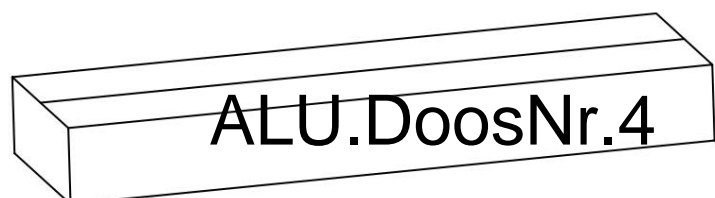





















GM800600

	ONDERDEELNR	AANTAL
1	 L02B	2
2	 L11B	2
3	 L05B	4
4	 L05E	3
5	 L06B	1
6	 L07B	2
7	 L08B	2
8	 L09B	2









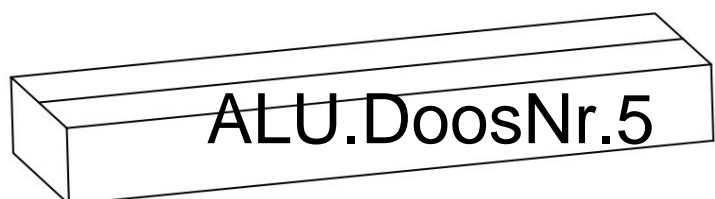

GM800600 Doos 2

	ONDERDEELNR	AANTAL
1	 L02A	2
	 L11A	2
2	 L04A	4
3	 L10	2
	 L15A	2
4	 L19A	4
	 L20	2
	 L21	2



ONDERDEELNR	AANTAL
 A54	2
 A56	3
 D07	4
 A01	4
 A03	2
 A04	2
 D26	1
 D25	2
 D129	6
 S05 M6X10	136
 M03 M6	112
 S28 M4X10	8
 M02 M4	8
 S08 M8X60	4
 Z08 M4.2X16	6
 Z02 4X14D	20
 J54	2
 J95	8

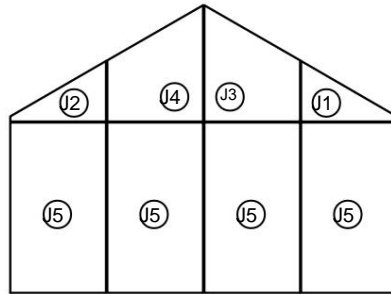
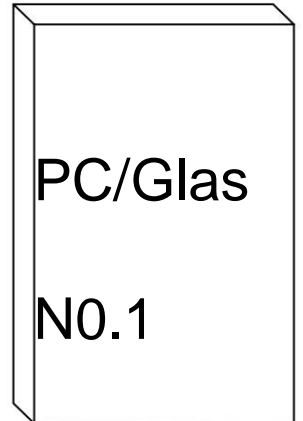

GM800550

ONDERDEELNR	AANTAL
	J1 3
	J2 3
	J3 1
	J4 1
	J5 6
	J6 6
	J9 2
	J11 2



ONDERDEELNR	AANTAL
	J7 8
	J8 4
	J10 2

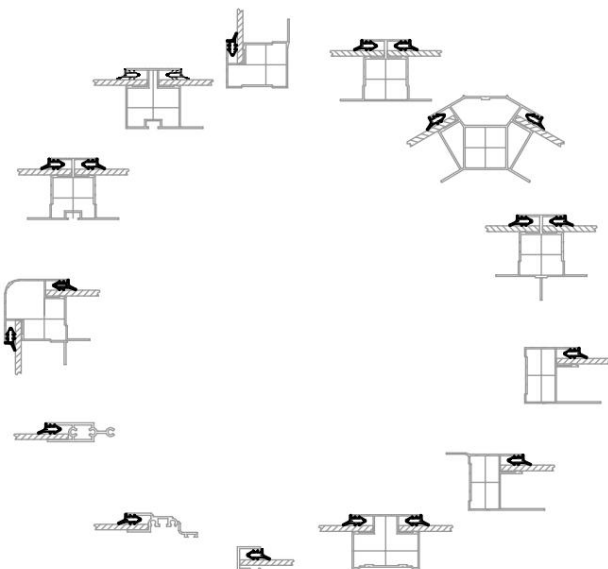
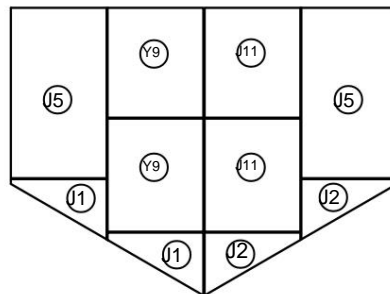
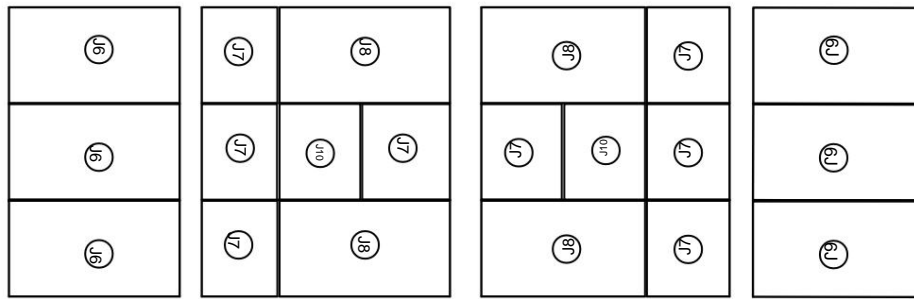

Rubber voor muren en dak
(Alleen voorzien voor glazen panelen)

ONDERDEELNR	AANTAL
	J108 156M



Alleen rubber voor muren
(Alleen voorzien voor glazen panelen)

ONDERDEELNR	AANTAL
	J108 97M

GM800650

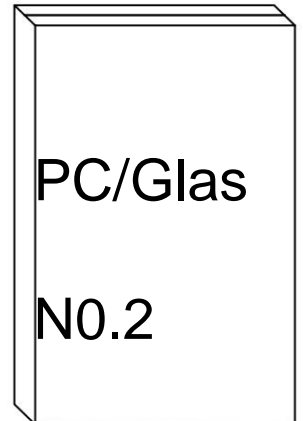
ONDERDEELNR	AANTAL
	J6 4



ONDERDEELNR	AANTAL
	J7 6
	J8 2
	J10 2

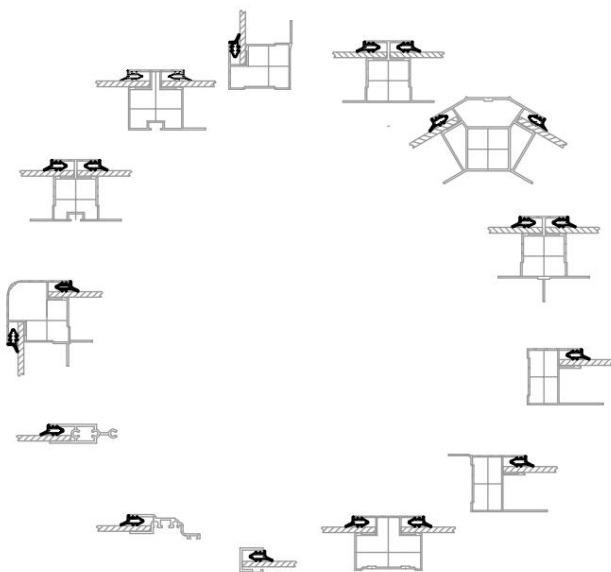
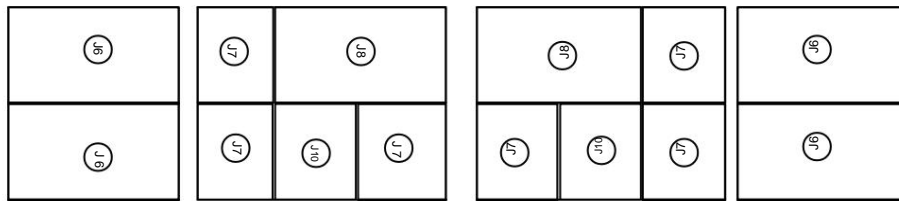

Rubber voor muren en dak
(Alleen voorzien voor glazen panelen)

ONDERDEELNR	AANTAL
	J108 52,2M

Alleen rubber voor muren
(Alleen voorzien voor glazen panelen)

ONDERDEELNR	AANTAL
	J108 15,7M

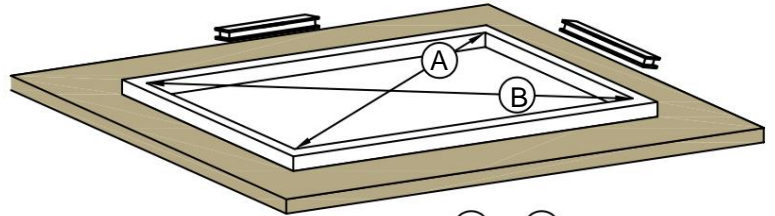
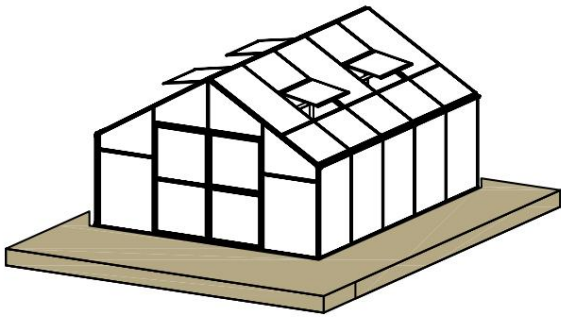

(A) = (B)

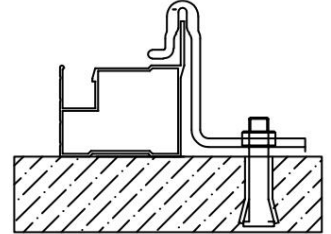
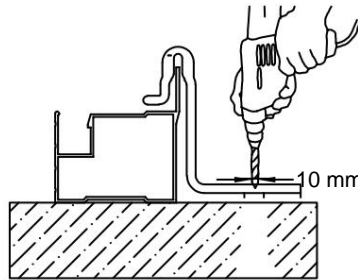

Expansieschroef/
betongrond

Het is essentieel dat de afmetingen a + b hetzelfde zijn om ervoor te zorgen dat de basis hetzelfde is vierkant.

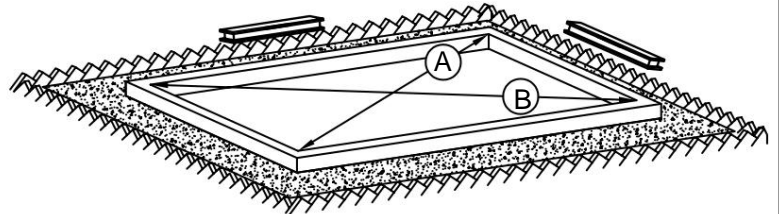
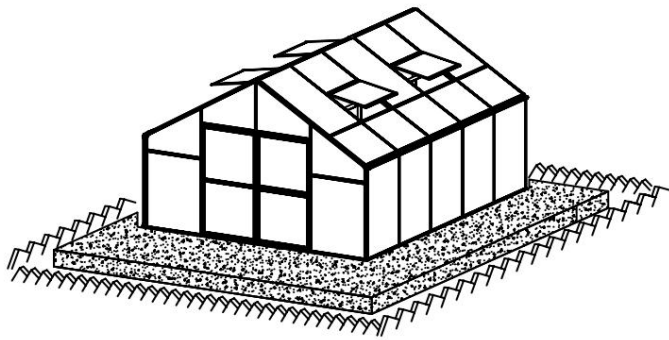

(A) = (B)

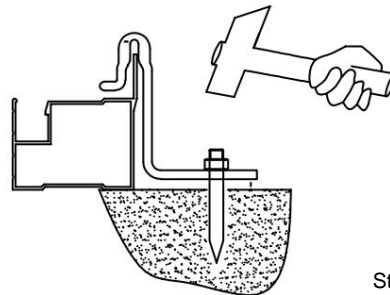

Stalen pinnen in de grond

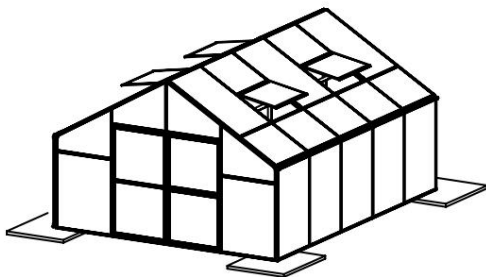

Alleen de ondersteuning op de hoeken is onvoldoende.

GM805850

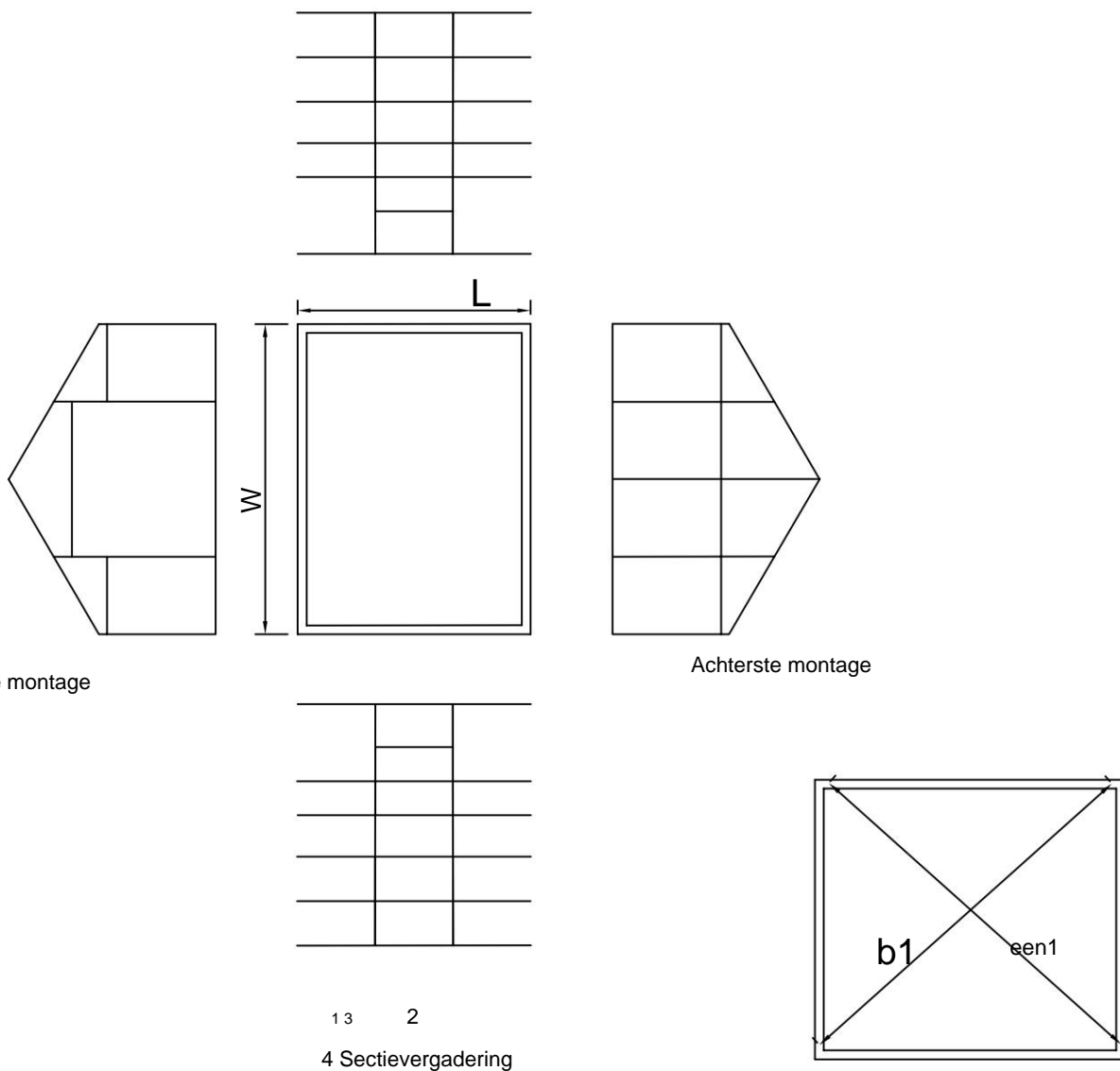



Afm/Model	GM805850	GM805850	GM805870	GM805885	
W (mm)	4064,6	4064,6	4064,6	4064,6	
L (mm)	3062,6	5066,6	7070,6	9074,6	
een=b (mm)	5089,3	6495,5	8155,6	9943,3	
a1=b1 (mm)	4963,2	6369	8032,8	9824,5	

- * W= Buitenbreedte van basisprofielen
- * L= Buitenlengte van basisprofielen
- * a=b= Buitendiagonaal van basisprofielen
- * a1=b1= Binnendiagonaal van basisprofielen

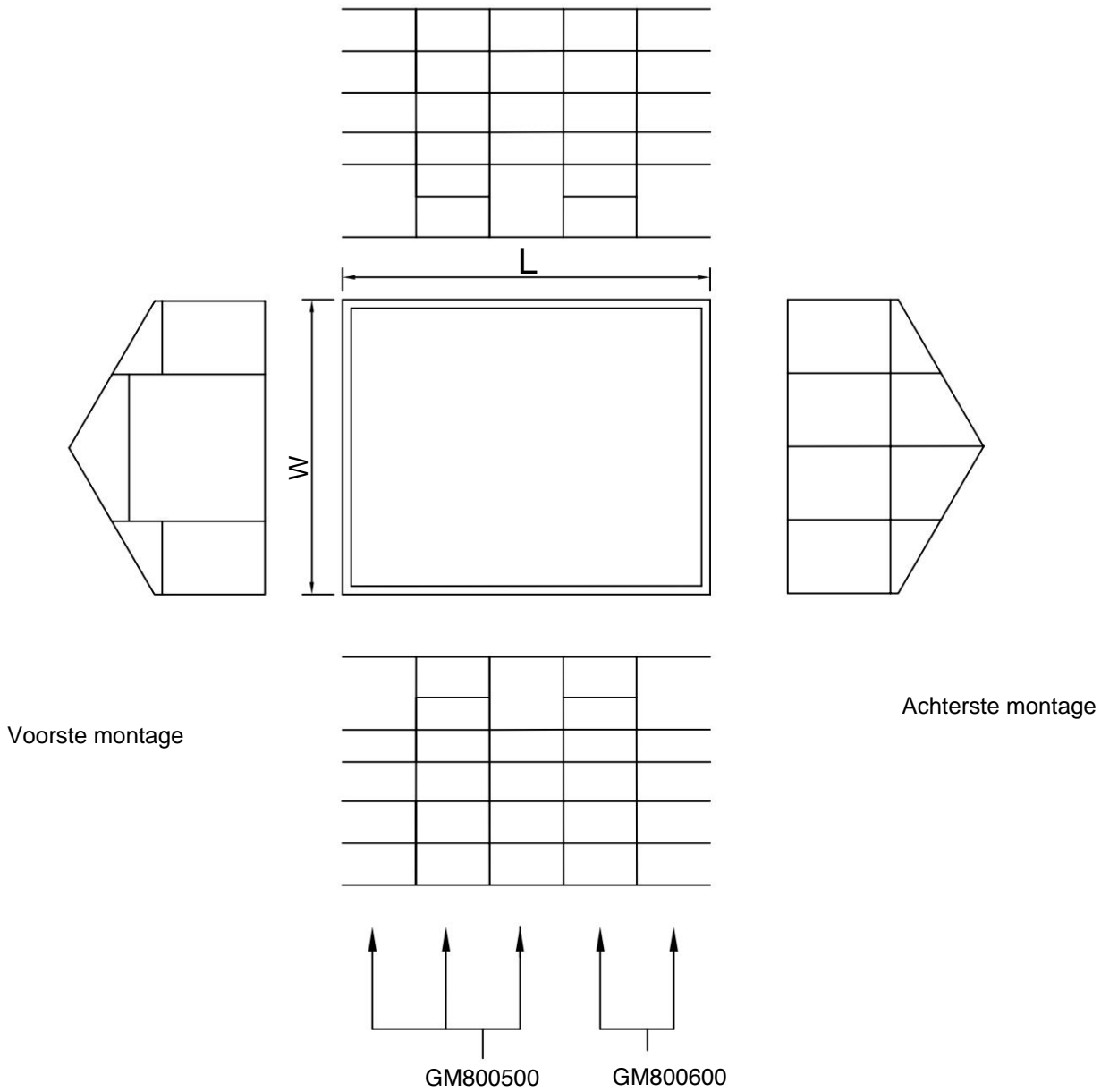
GM800500 + 1x GM



*Het basismodel kan eenvoudig worden uitgebreid door telkens een '2 sectie Assembly' toe te voegen voor een langere maat.

ONDERDEELNR	AANTAL
 D07	12
 S08 M8X60	12

GT403

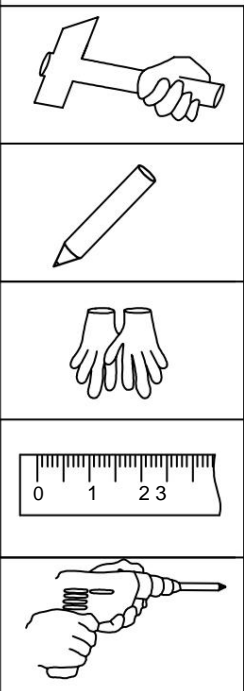
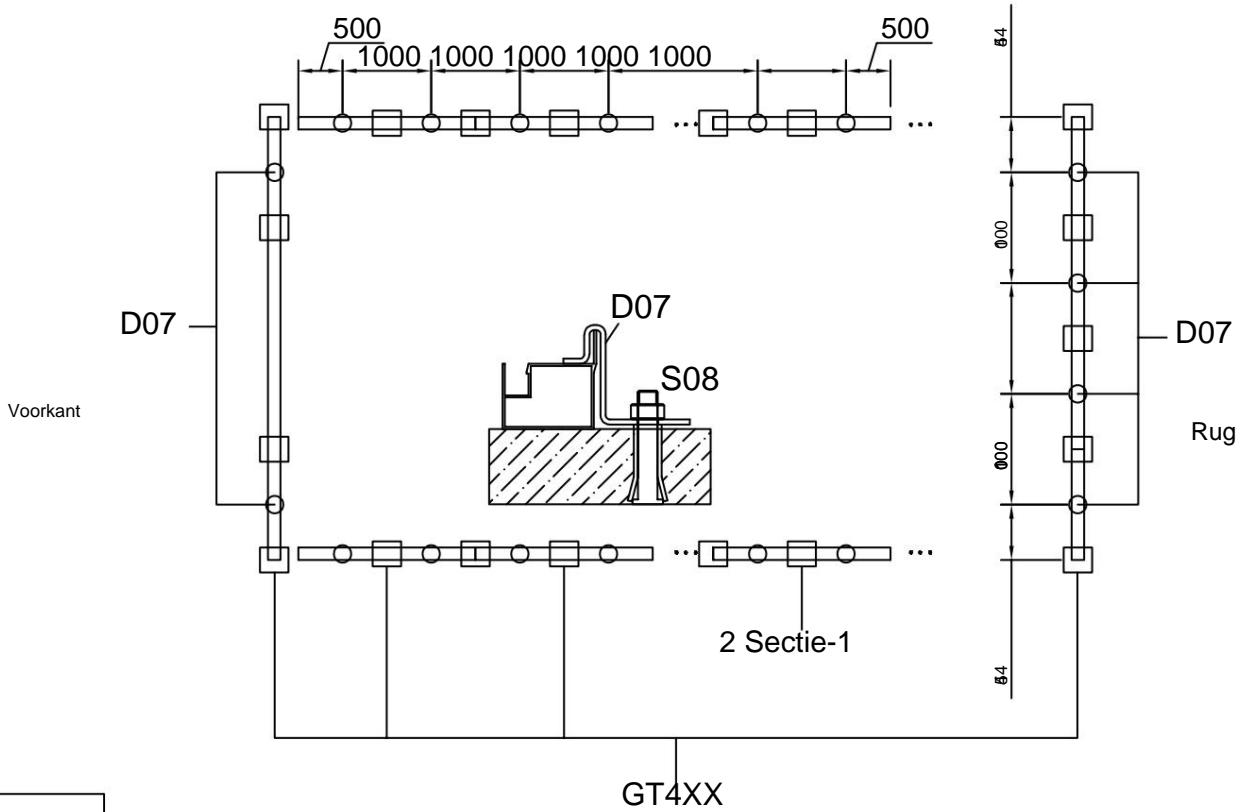

*Dit toont een lay-out voor de posities van de D07, waarbij deze voor elke sectie in het midden van het pc-paneel wordt geplaatst.

ONDERDEELNR	AANTAL
	L18C 1
	L17 1
	L16A 1
	L16G 1
	L16H 1
	L23A 2
	D77 4
	S26 M5X12 5
	S05 M6X12 3
	M03 M6 3
	Z08 M4.2X16 16
	J9 2

Deur-L-montage

Steek connector D77 in elk uiteinde van de profielen L16A & L16G & L16H & L18C.

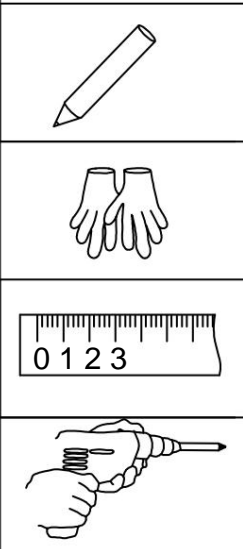
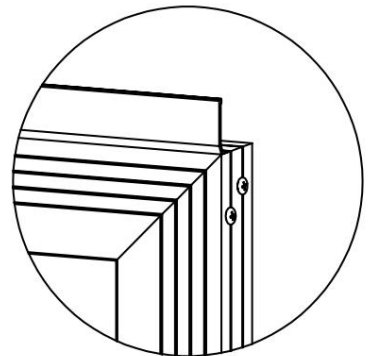
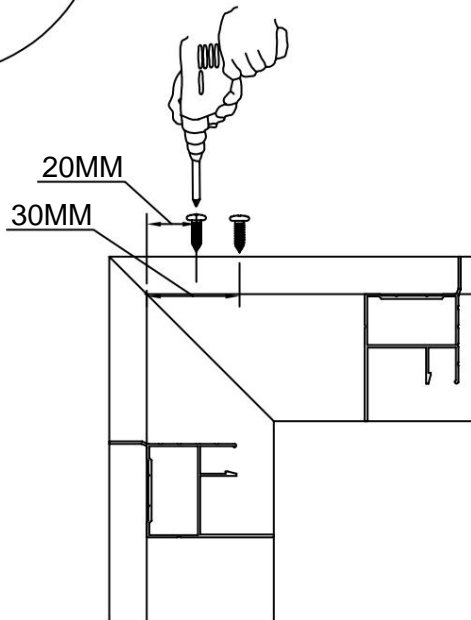
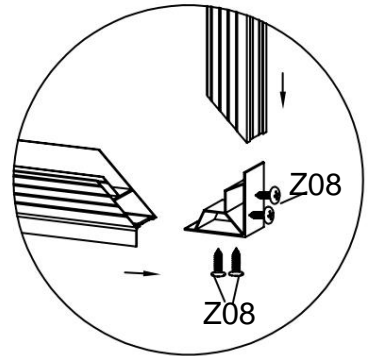
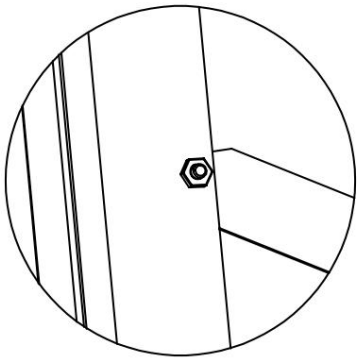
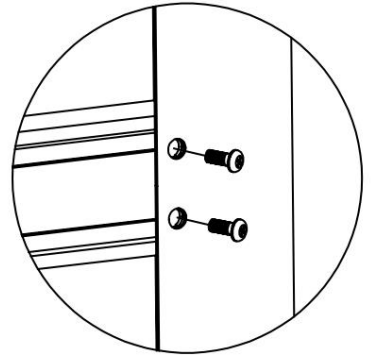
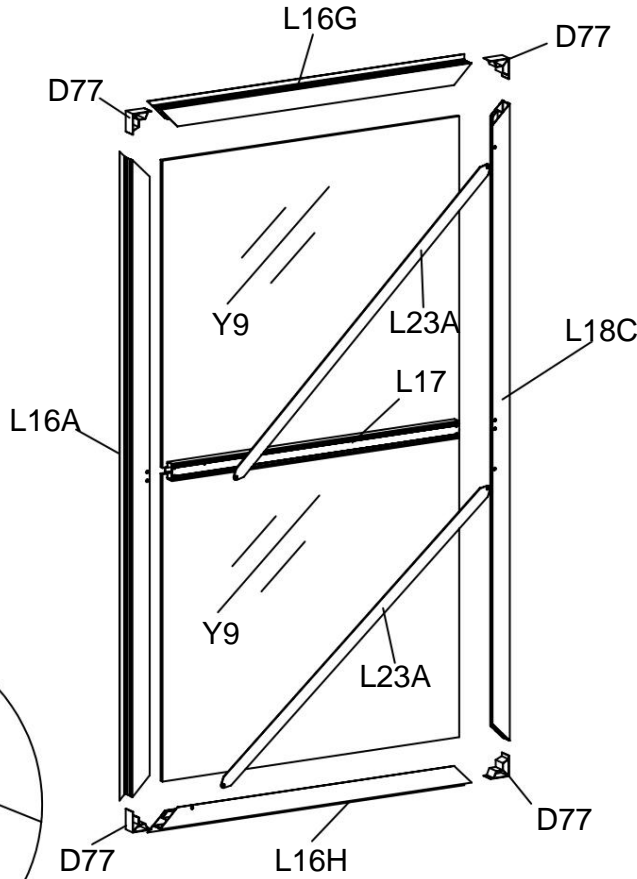

Markeer vervolgens de afstand vanaf elk uiteinde op ongeveer 20/30 mm.

Zet ze ten slotte vast met schroeven Z08 met behulp van de elektrische schroevendraaier.

ONDERDEELNR	AANTAL	
	L18A 2	
	L18B 1	
	L16B 1	
	L16C 1	
	L16D 1	
	L16E 1	
	L16F 1	
	L23A 2	
	D77 8 Z08	
	M4 2X16 32	
	S05	4
	M6X12	
	M03	4
	M6	
	J11 2	

Deur-R1-montage

Steek connector D77 in elk uiteinde van de profielen L16B & L16D & L16E & L18A en markeer vervolgens de afstand vanaf elk uiteinde op ongeveer 20/30MM.

Zet ze ten slotte vast met schroeven Z08 met behulp van de elektrische schroevendraaier.

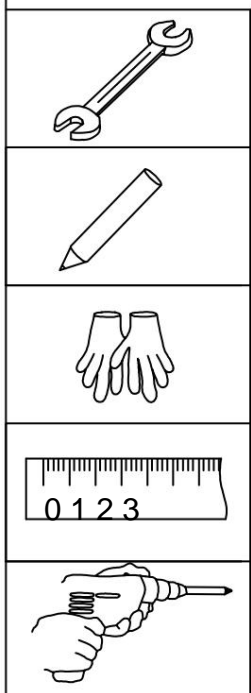
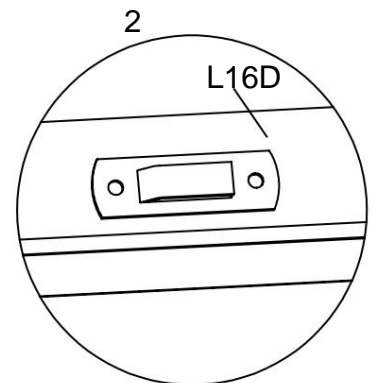
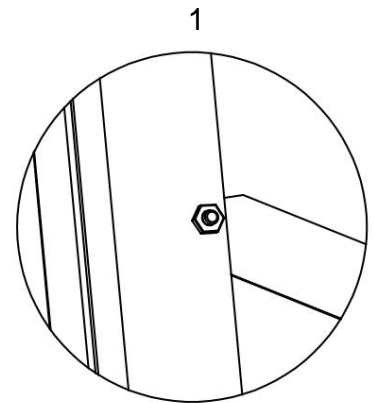
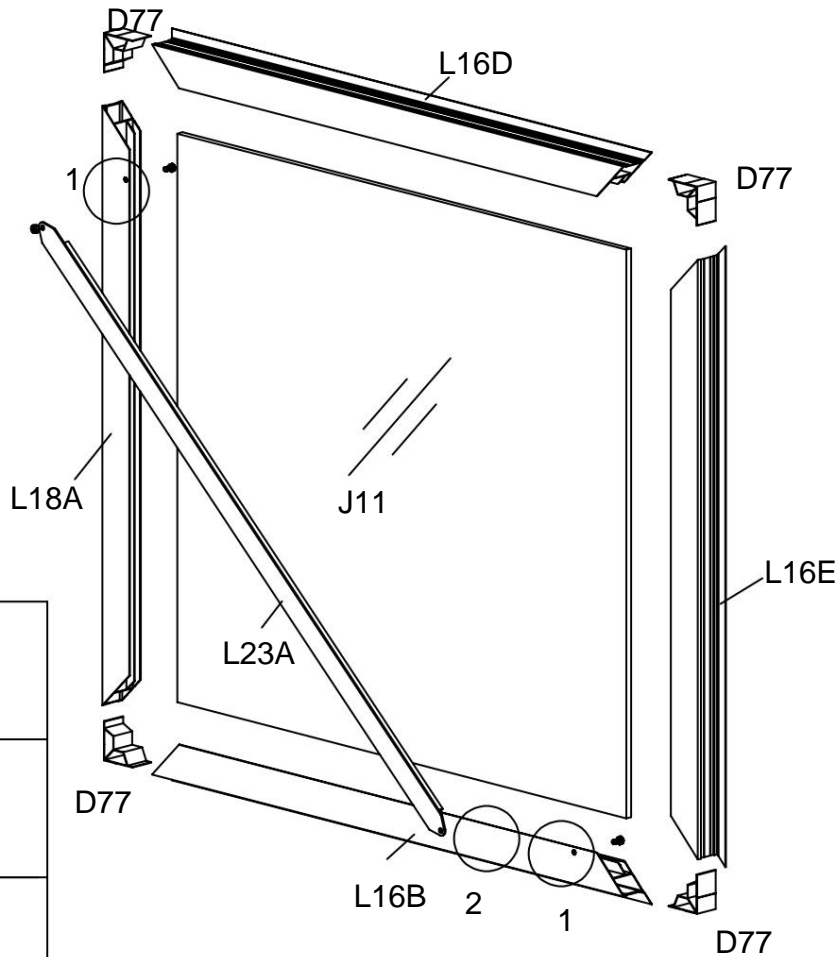
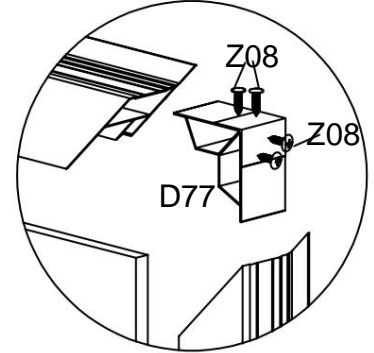
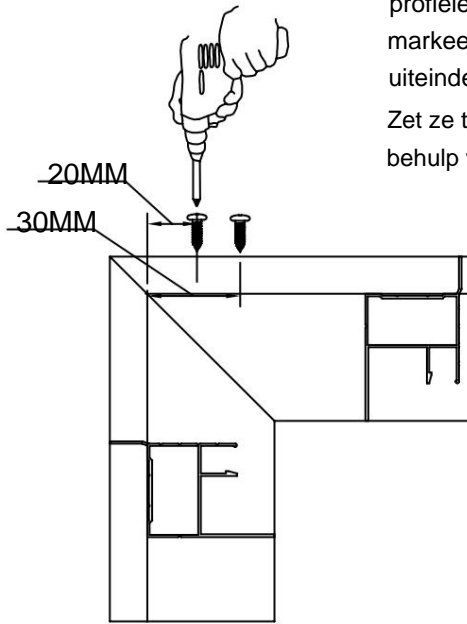







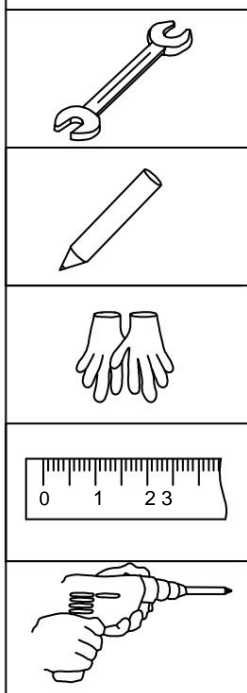
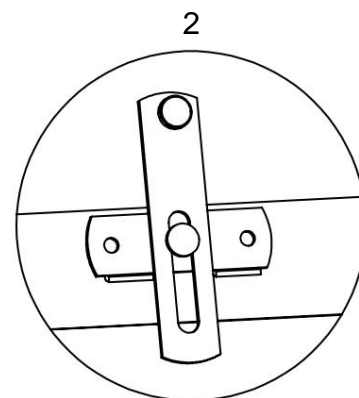
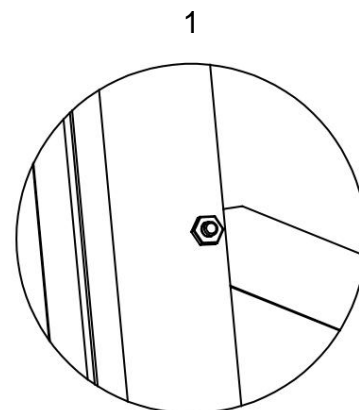
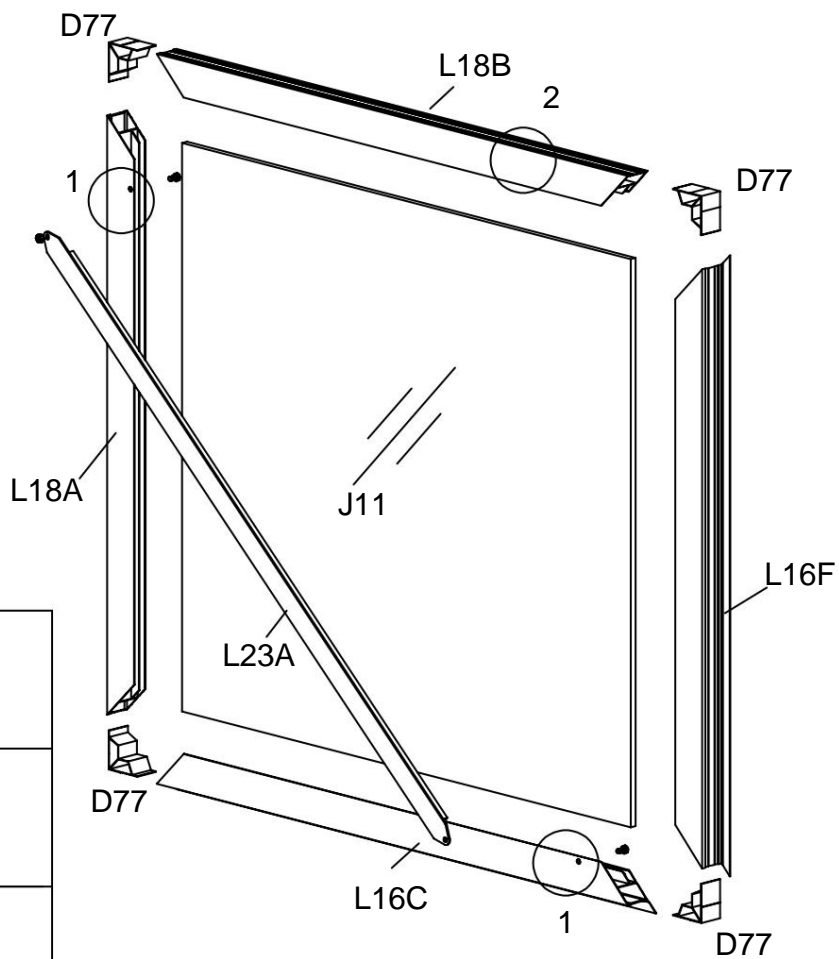
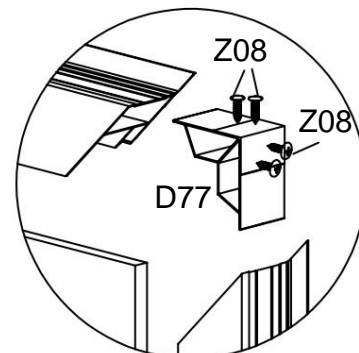
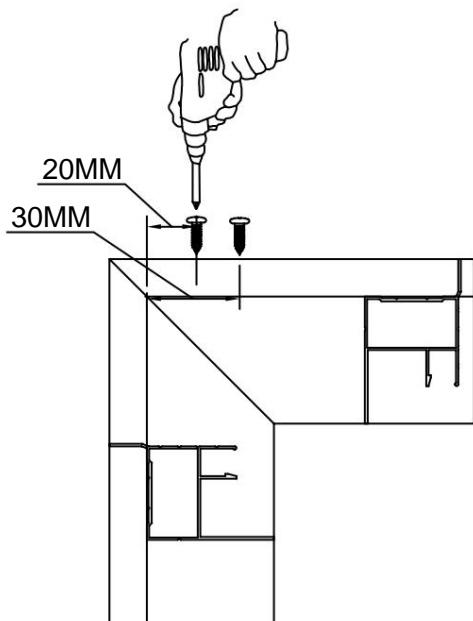







Deur-R2-montage

Steek connector D77 in elk uiteinde van de profielen L16C & L16F & L18A & L18B en markeer vervolgens de afstand vanaf elk uiteinde op ongeveer 20/30MM.

Zet ze ten slotte vast met schroeven Z08 met behulp van de elektrische schroevendraaier.



Montage dakventilatie

ONDERDEELNR.	AANTAL.
	L10 1
	L15A 1
	L19A 2
	L20 1
	L21 1
	A01 2
	S28 4
	M4X10 4
	M02 4
	M4 4
	Z08 2
	M4.2X16 2
	Z02 10
	4X14D 10
	J10 1

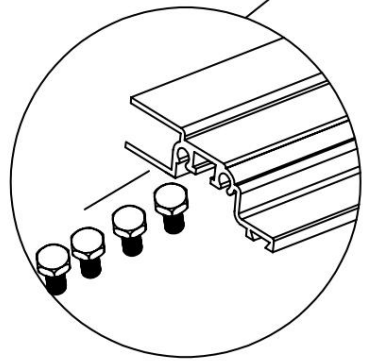
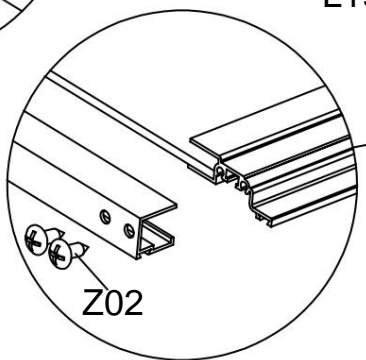
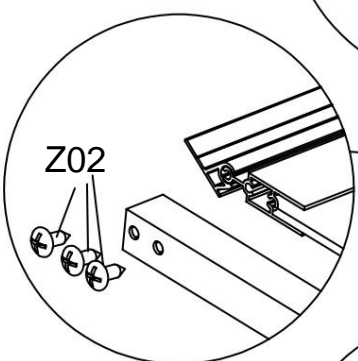
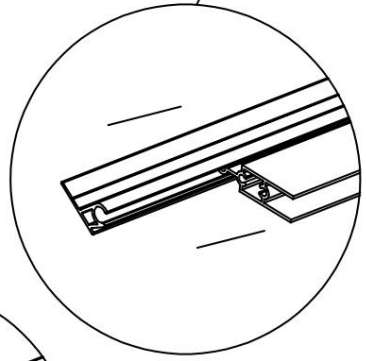
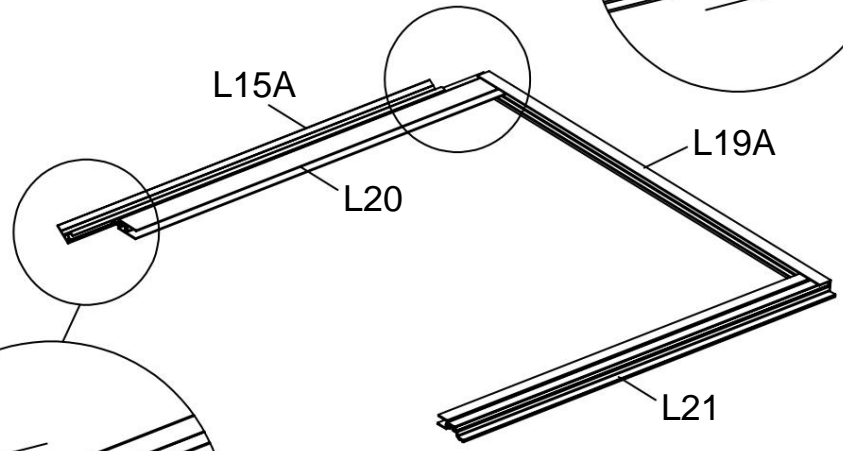
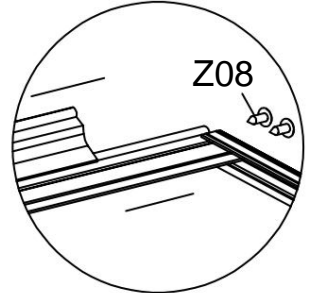





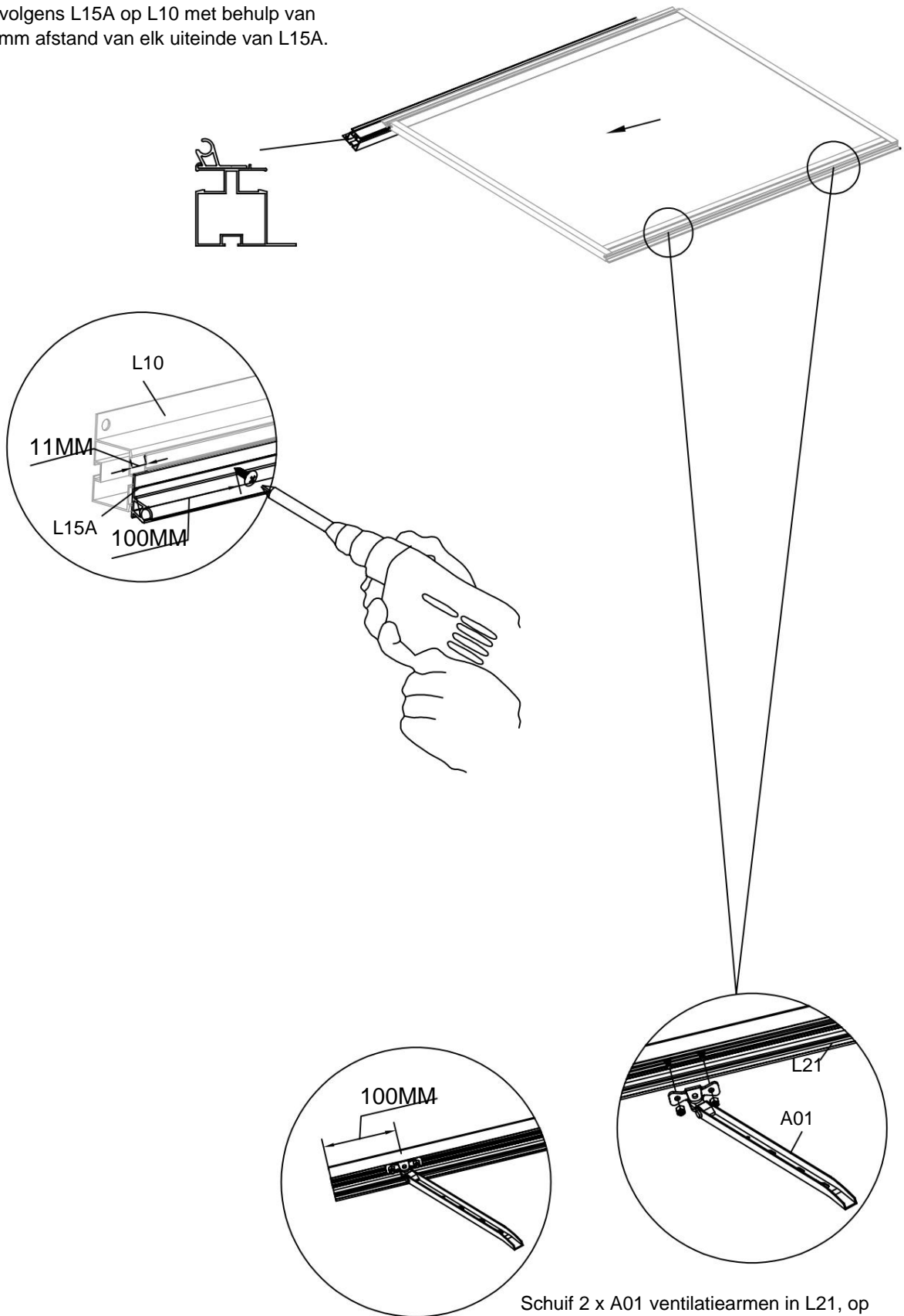



Schuif de hele vleugel in de groef van L10 en laat elke zijde van L15 11MM langer dan L10.









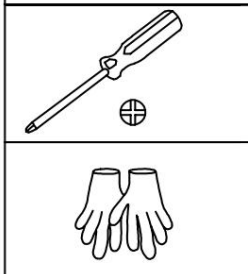
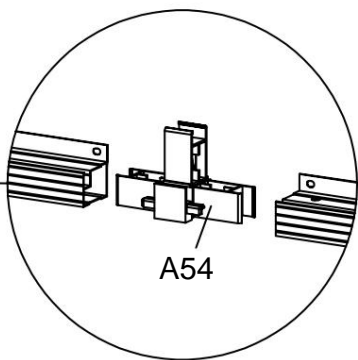
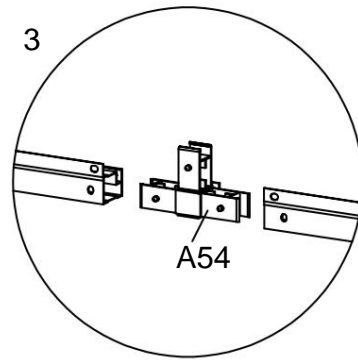
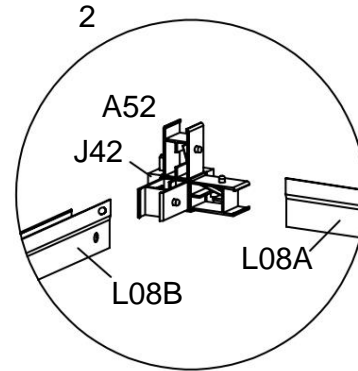
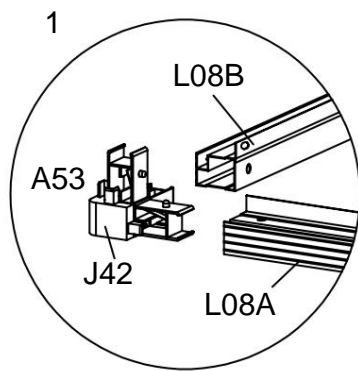
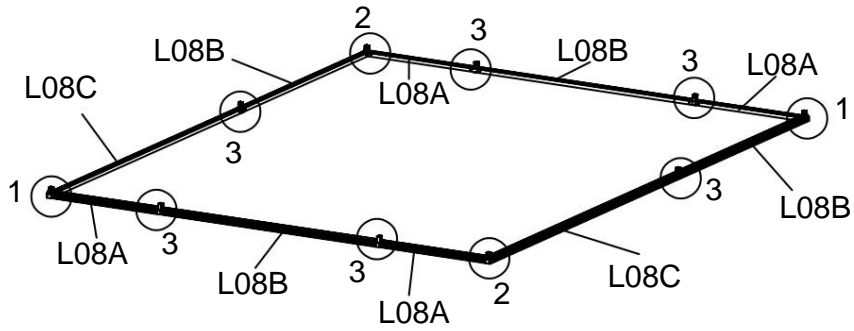

Bevestig vervolgens L15A op L10 met behulp van Z08, op 100 mm afstand van elk uiteinde van L15A.











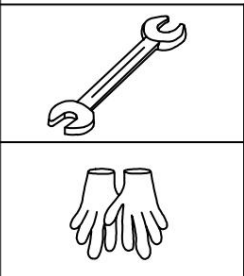
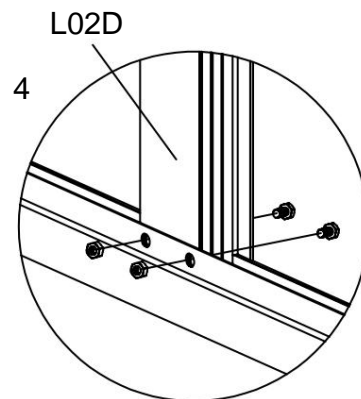
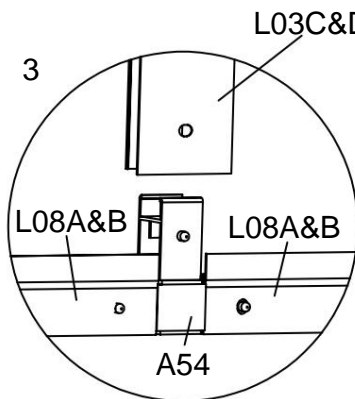
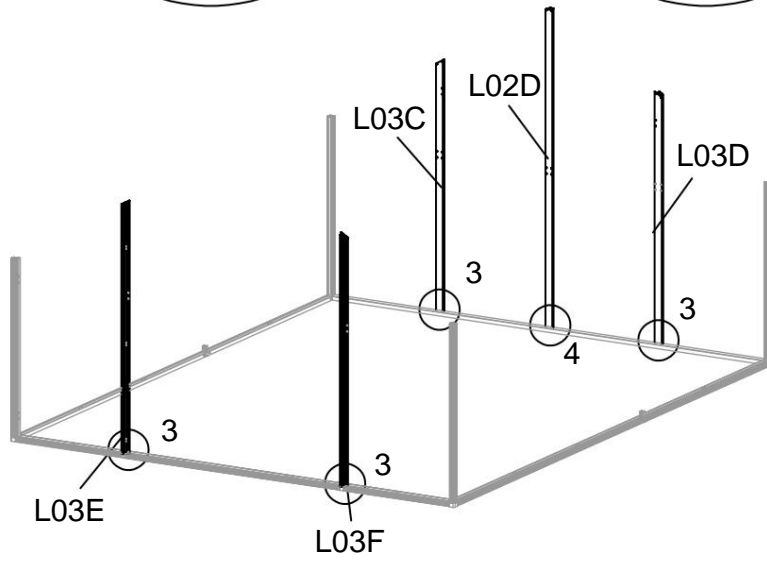
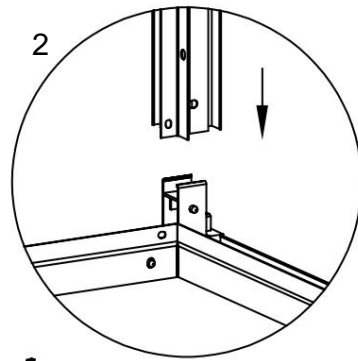
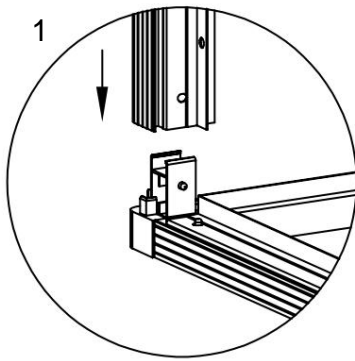
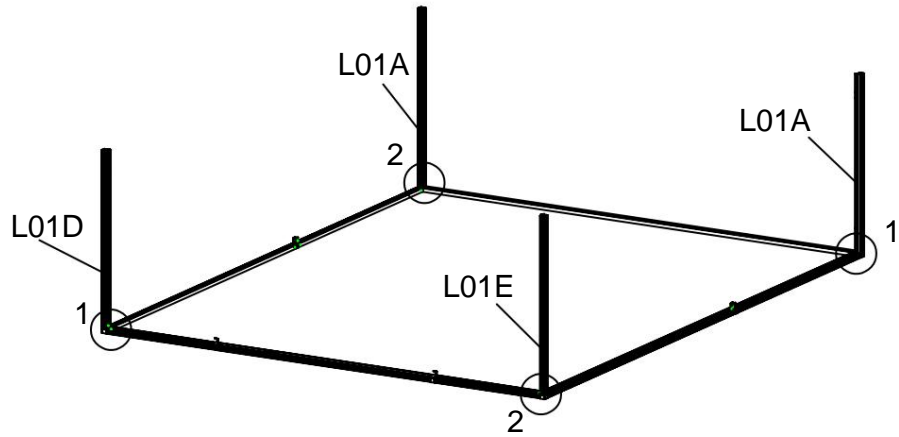



Schuif 2 x A01 ventilatiearmen in L21, op 100 mm afstand van elk uiteinde van L21.
Beveilig ze vervolgens met S28 & M02.

ONDERDEELNR	AANTAL
	L08A 4
	L08B 4
	L08C 2
	A52 2
	A53 2
	A54 6
	J42 4
	J54 6



ONDERDEELNR	AANTAL
	L01A 2
	L01D 1
	L01E 1
	L02D 1
	L03C 1
	L03D 1
	L03E 1
	L03F 1
	S05 M6X10 2
	M03 M6 2



ONDERDEELNR	AANTAL
	L11A 2
	L05A 2
	L05B 2
	L07B 2
	L07C 2
	A55 4
	A56 2
	J95 4
	S05
	M6X10 20
	M03
	M6 20

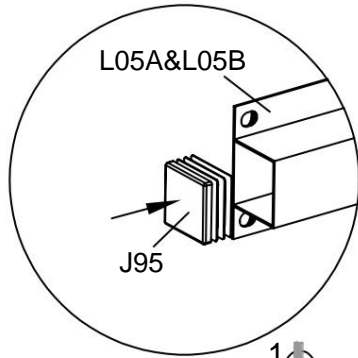



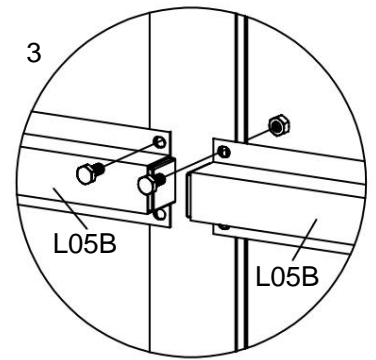
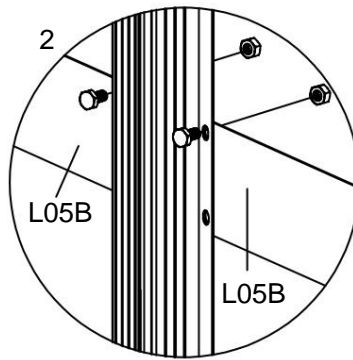
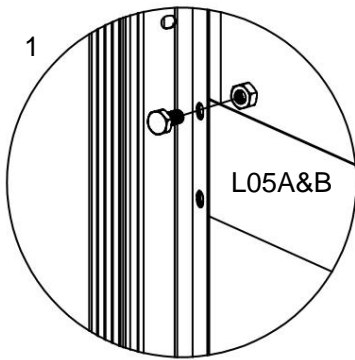
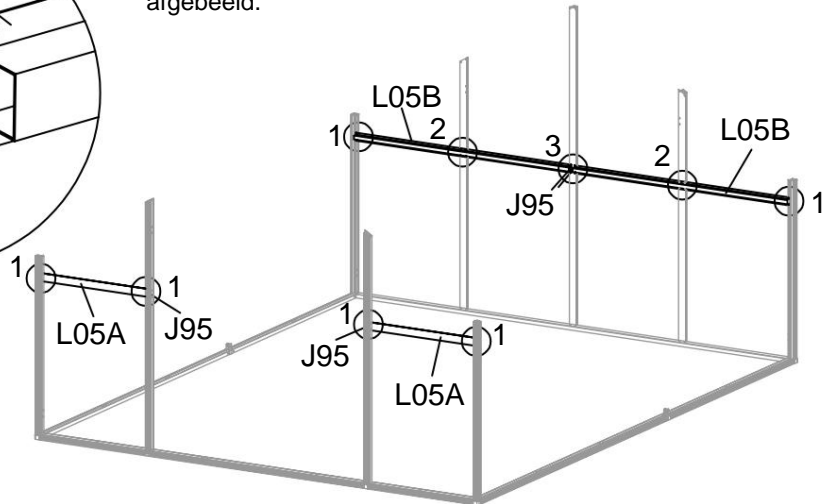

Plaats J95 in L05A en L05B zoals afgebeeld.

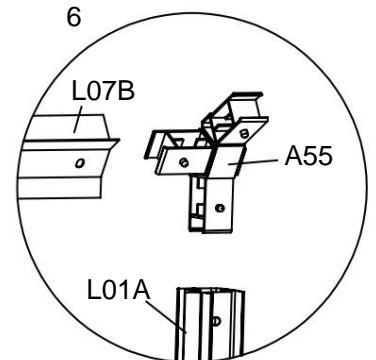
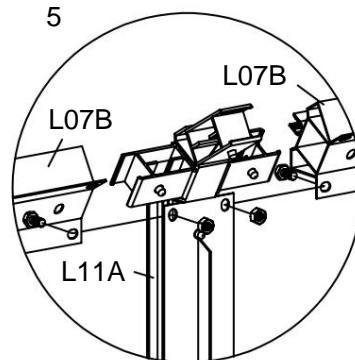
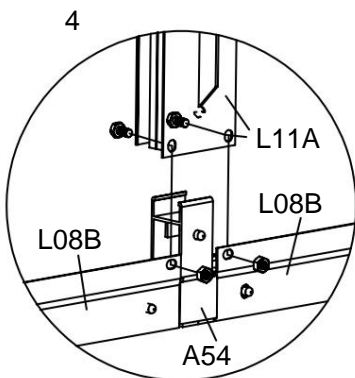
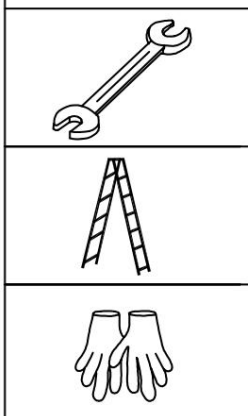
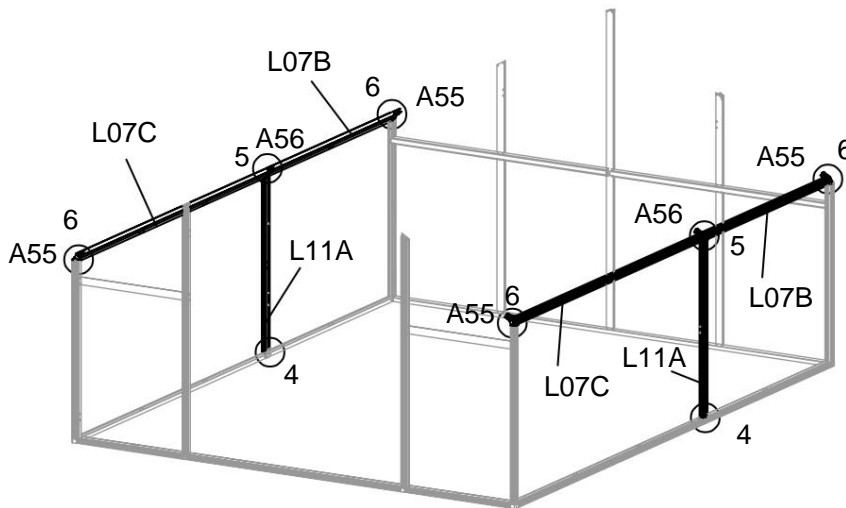

Vergrendel de bovenste gaten van L05A & L05B met behulp van S05 & M03.
Laat de onderstaande gaten van L05A en L05B open voor latere montage van L04B.







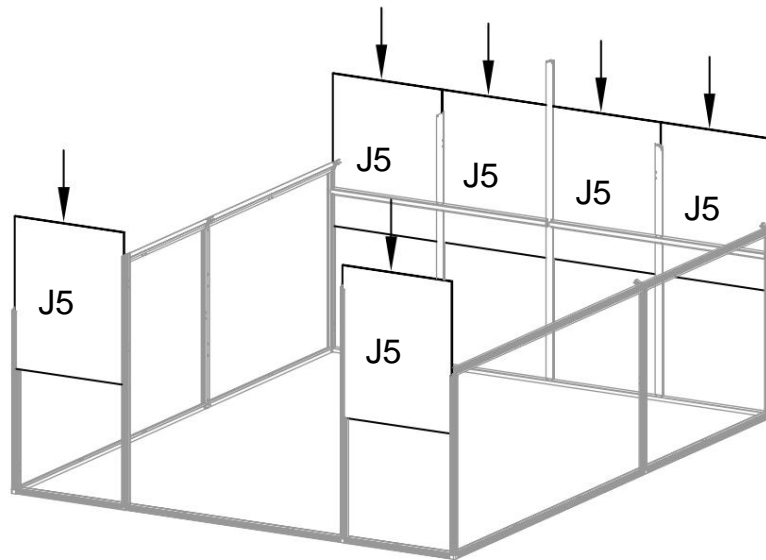

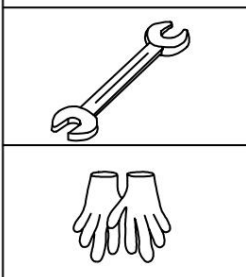
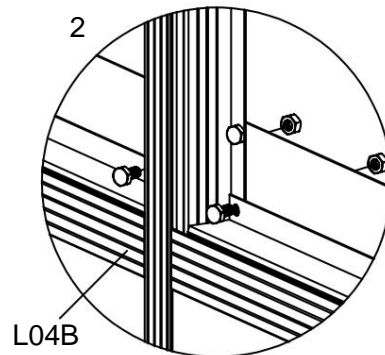
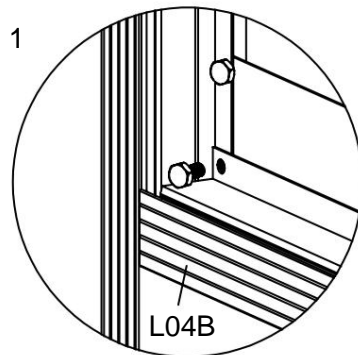
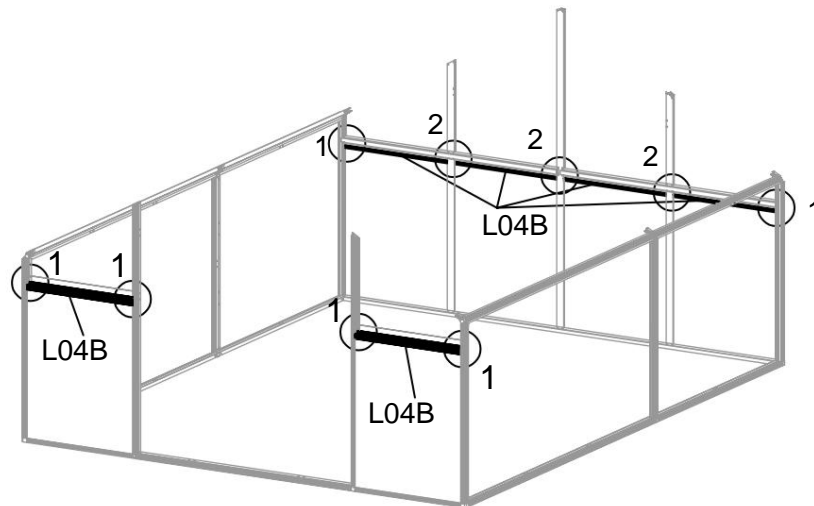

ONDERDEELNR	AANTAL
 L04B	6
 J5	6
 S05 M6X10	12
 M03 M6	12

Steek het paneel Y5 in het kanaal van de profielen zoals afgebeeld.



Bevestig L04B aan de onderstaande gaten van L05A en L05B met behulp van S05 en M03.



ONDERDEELNR	AANTAL
	L05B 2
	L05C 2
	L02A 6
	J95 4
	S05
	M6X10 64
	M03
	M6 64

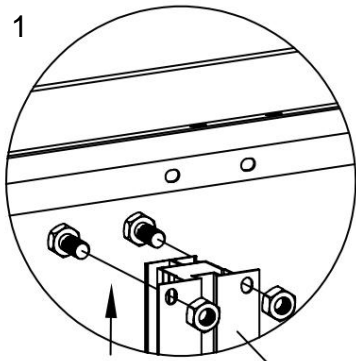
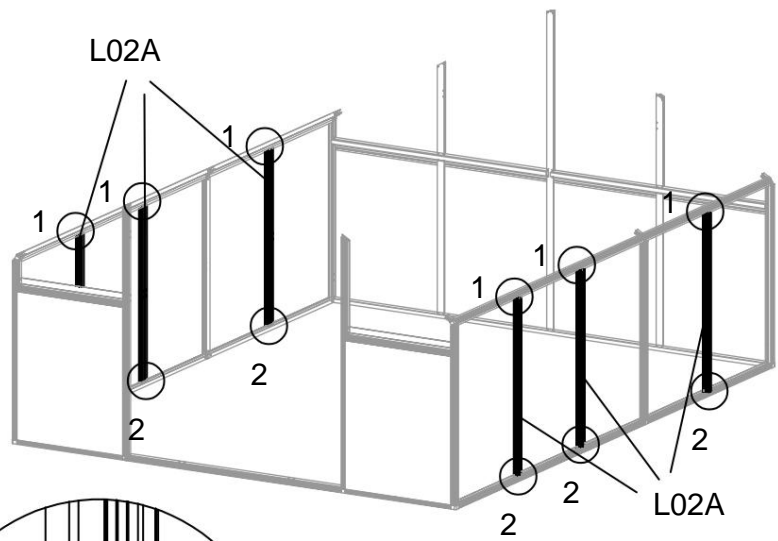



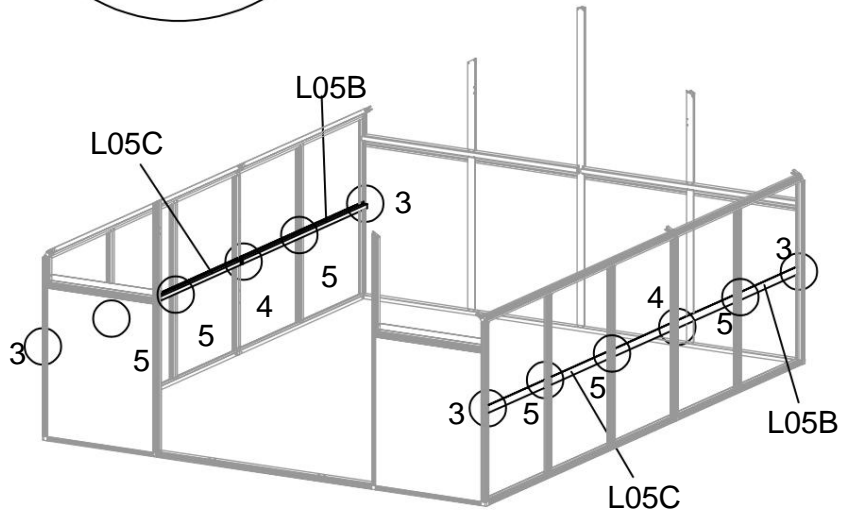
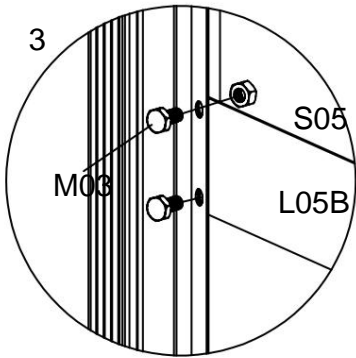
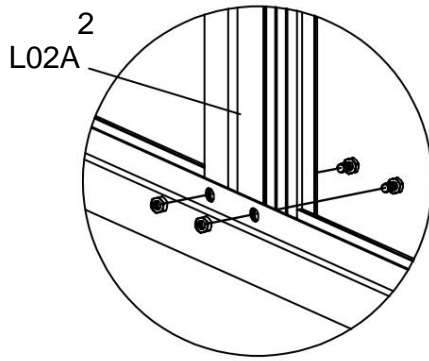

L02A

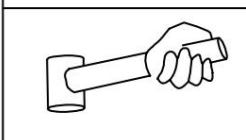
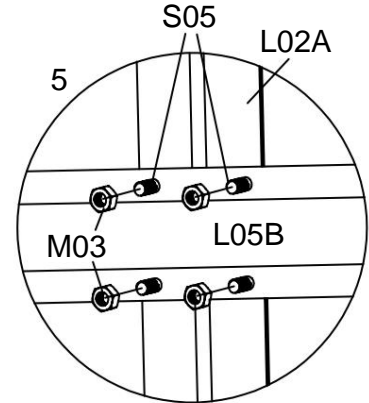
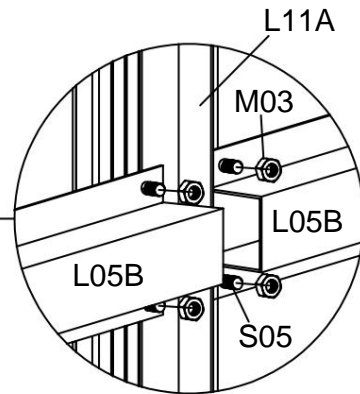
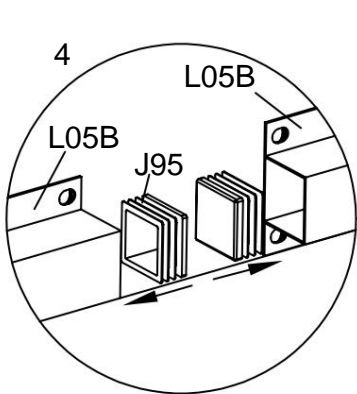









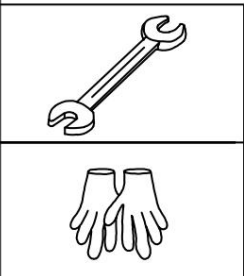
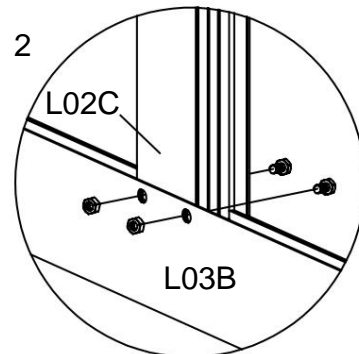
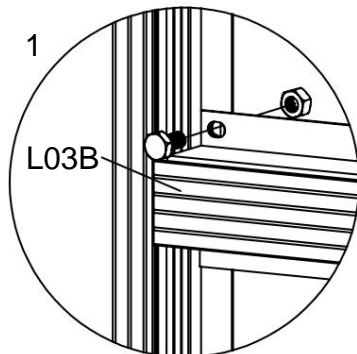
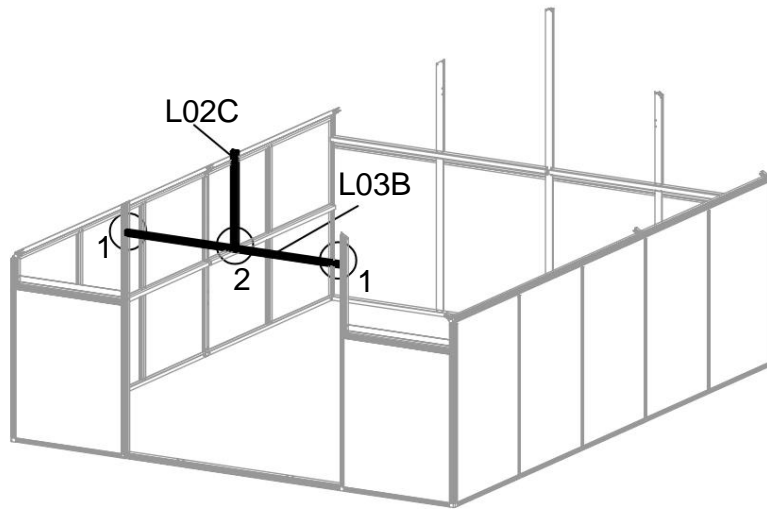
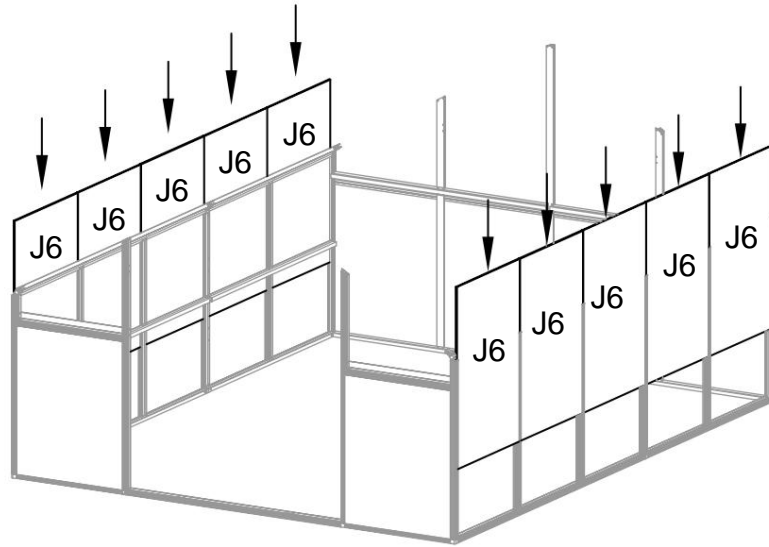





Steek de dop J95 in één uiteinde van elke L05B, zoals weergegeven in afbeelding 4.



ONDERDEELNR	AANTAL
 L02C	1
 L03B	1
 J6	10
 S05 M6X10	4
 M03 M6	4

Montagepaneel Y6 zoals afgebeeld.





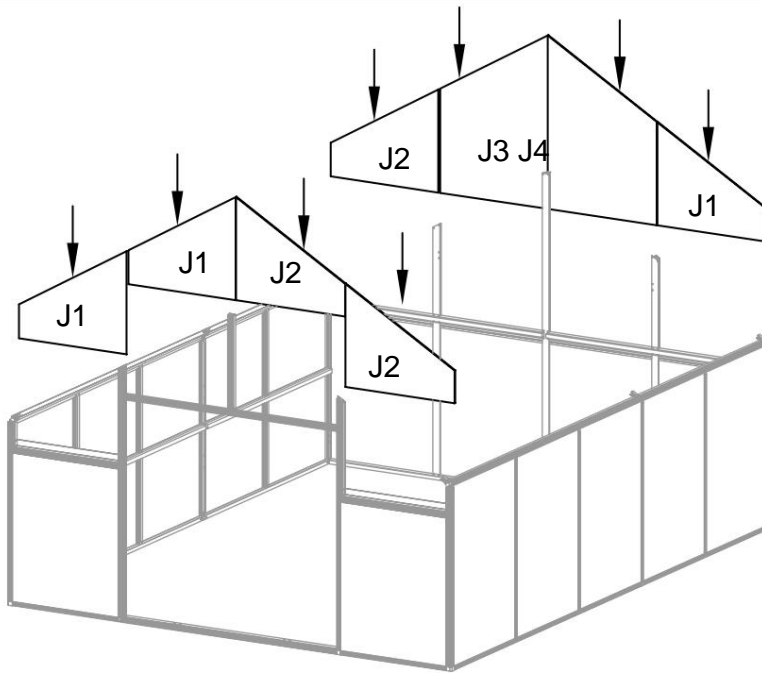

ONDERDEELNR	AANTAL
	L01B 2
	L01C 2
	L11B 2
	J1 3
	J2 3
	J3 1
	J4 1
	A55 2
	A56 1
	S05
	M6X10 12
	M03
	M6 12

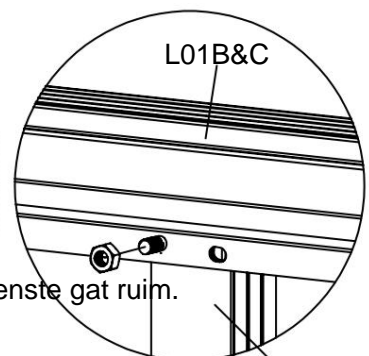
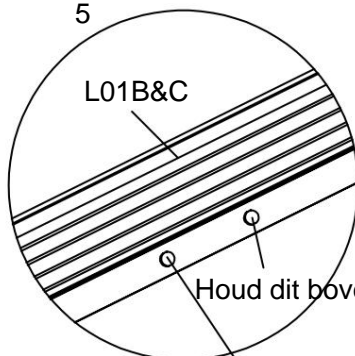
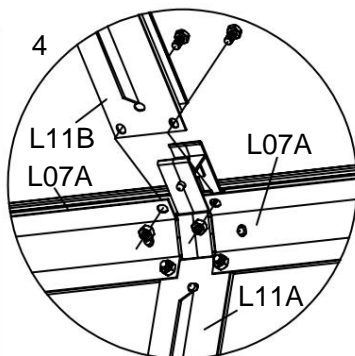
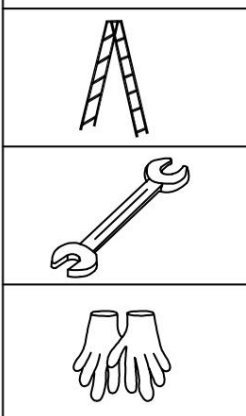
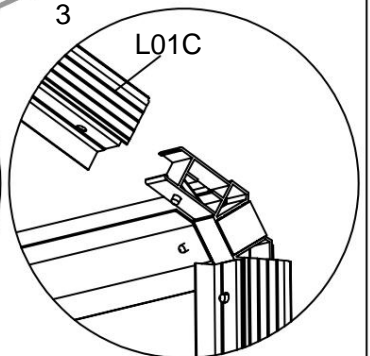
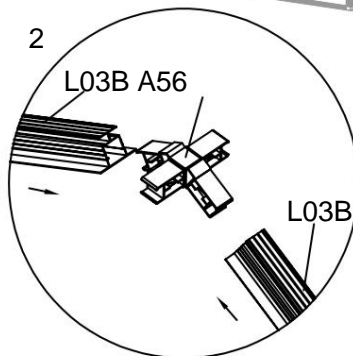
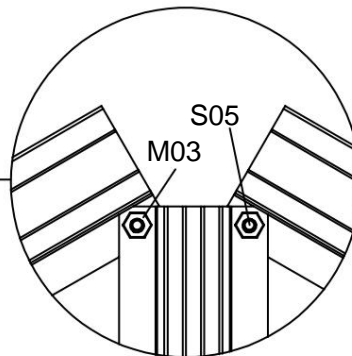
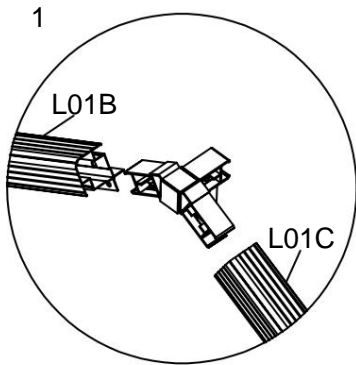
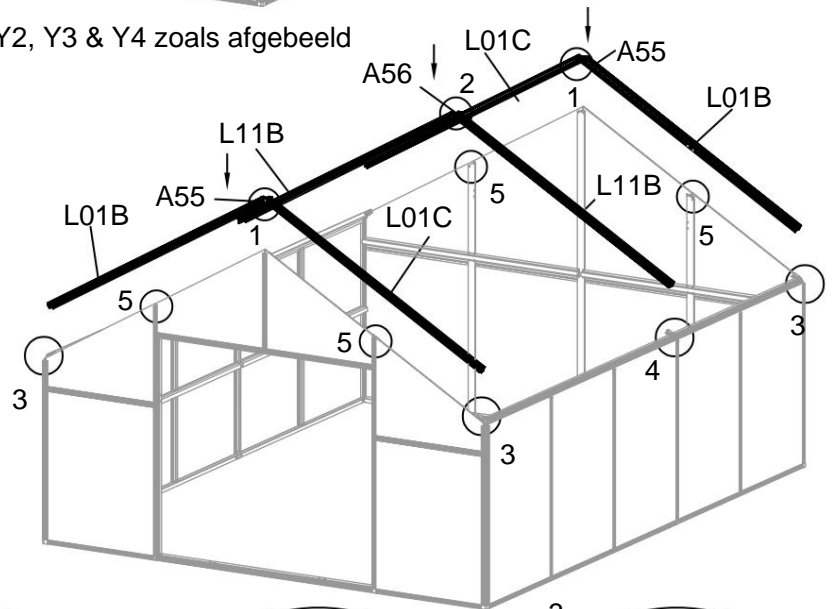







Montagepaneel Y1, Y2, Y3 & Y4 zoals afgebeeld

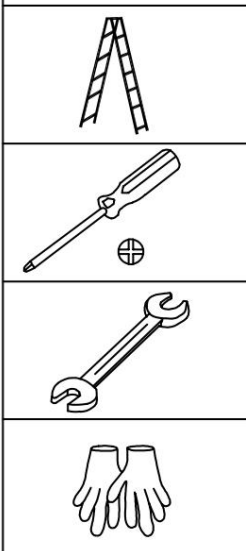
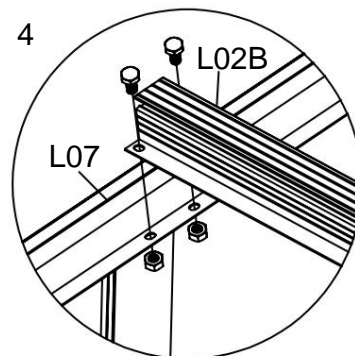
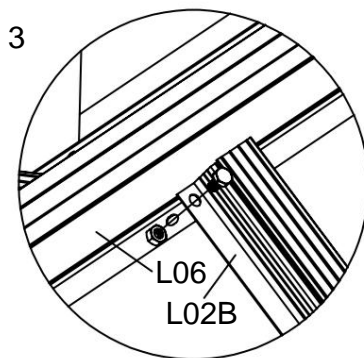
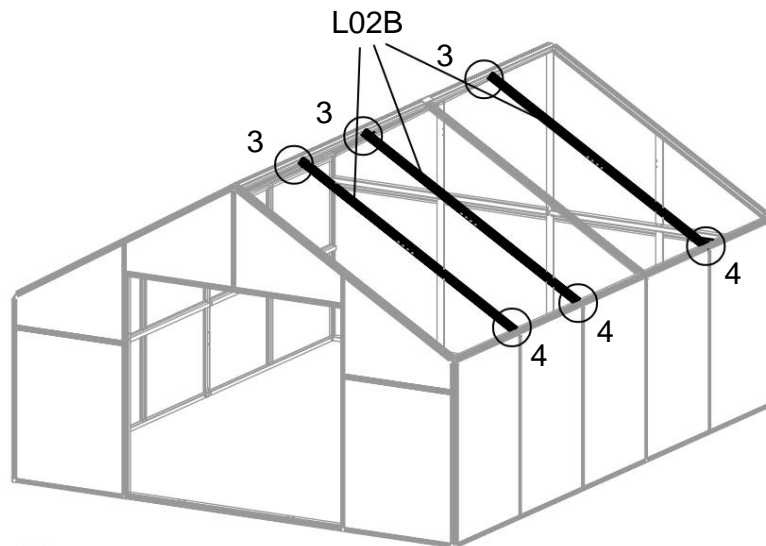
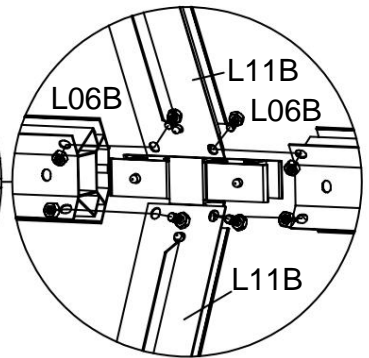
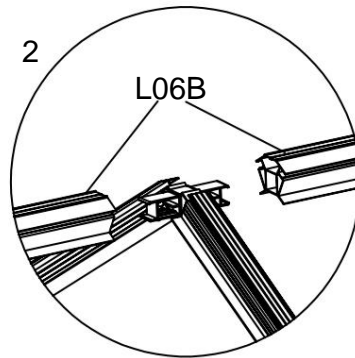
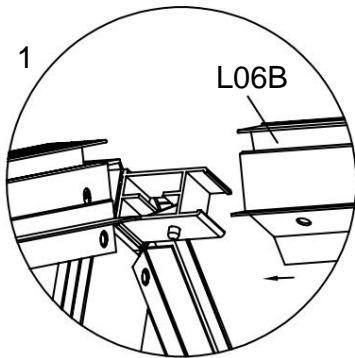
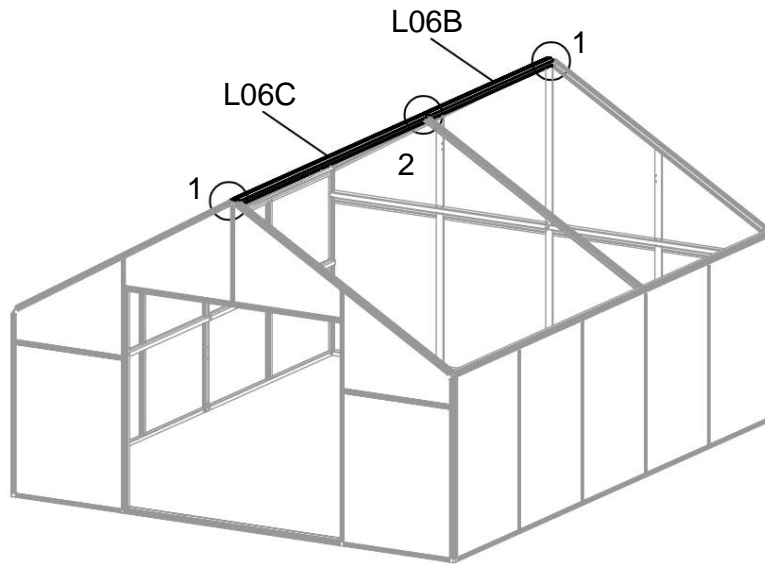

Bevestig L01B&C aan L02E&F&G&H via dit onderstaande gat.

ONDERDEELNR	AANTAL
	L02B 6
	L06B 1
	L06C 1
	S05 M6X10 28
	M03 M6 28



ONDERDEELNR	AANTAL
	L05E 3
	D26 1
	D129 6
	Z08 M4,2X16 2
	S05 M6X12 24
	M03 M6 24

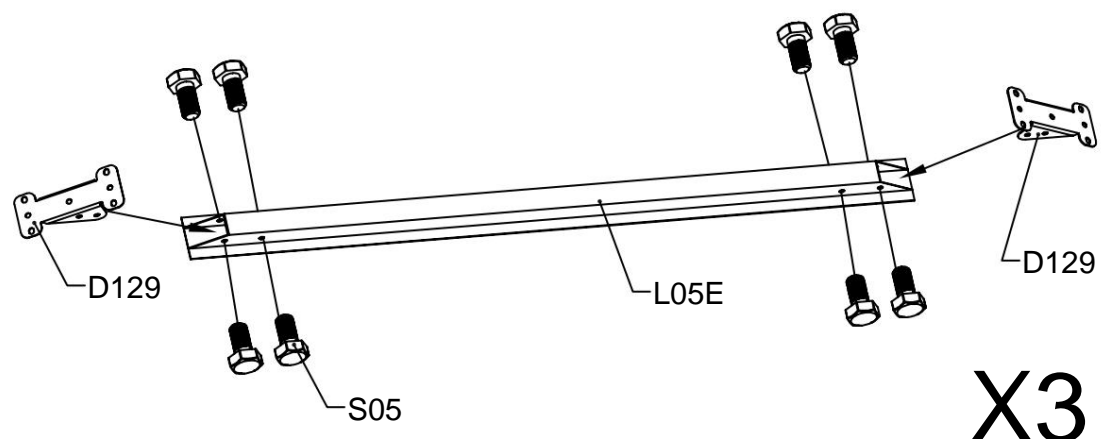



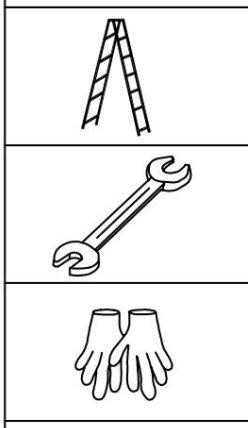

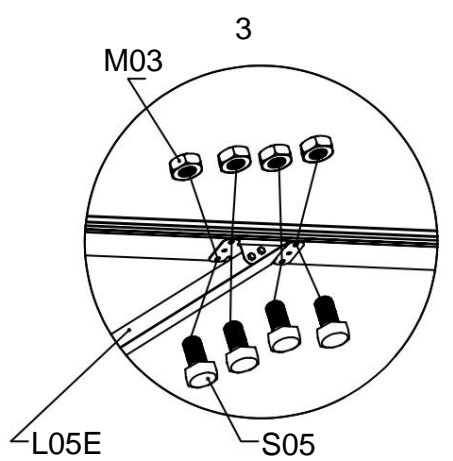
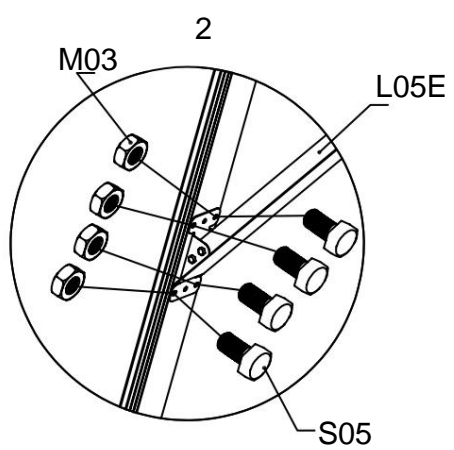
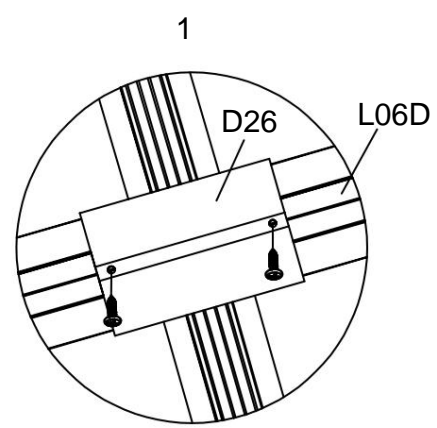
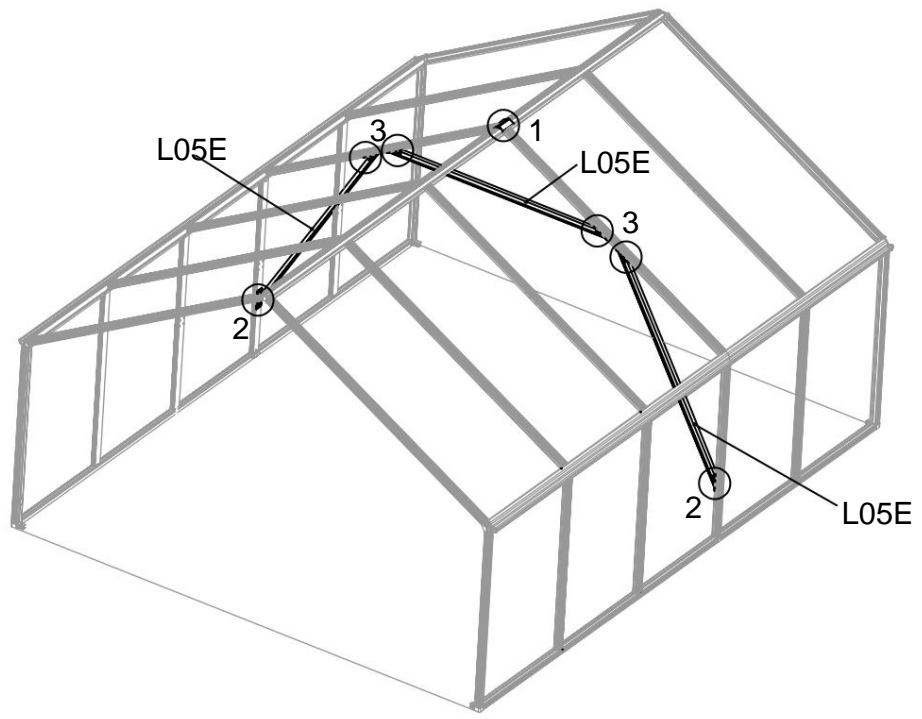

X3



Wanneer u de L05E installeert voordat u de moeren en bouten vastdraait, duwt u deze onder de nok nabij de verbinding omhoog om er zeker van te zijn dat de hele nok recht is.



ONDERDEELNR	AANTAL
	RAAM 4
	L05B 2
	L05C 2
	J95 4
	S05 M6X10 48
	M03 M6 48
	J7 4

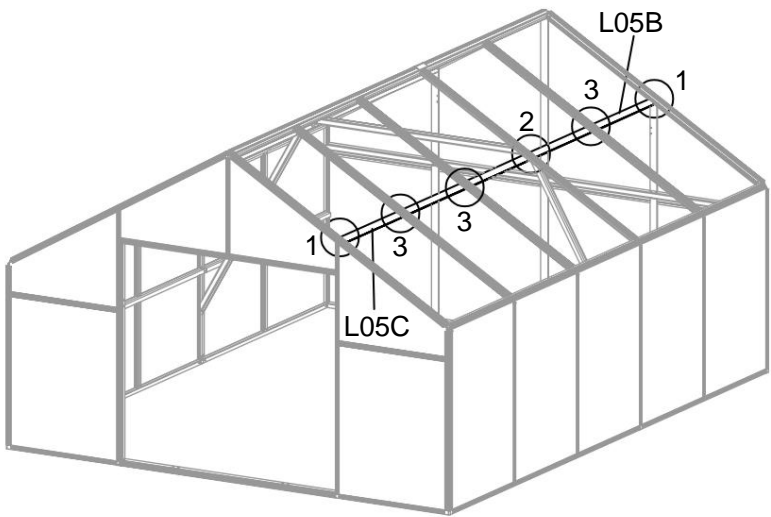



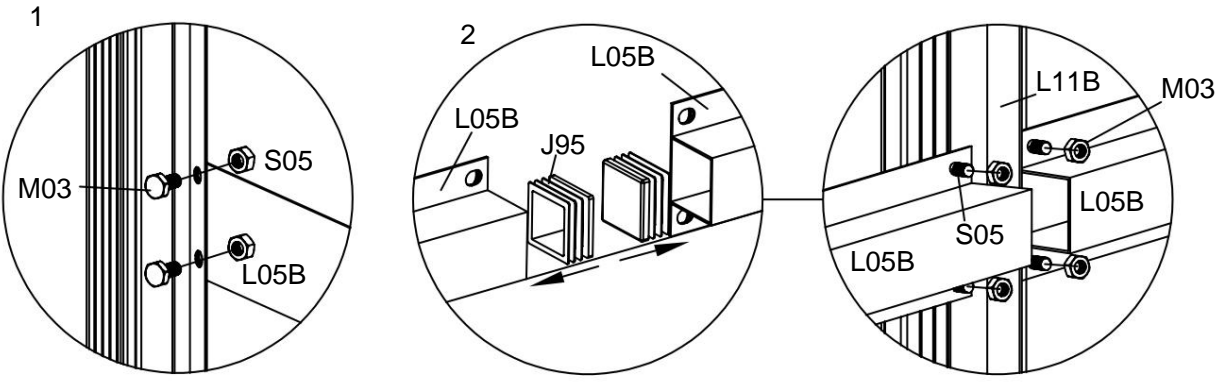

Plaats J95 in L05B

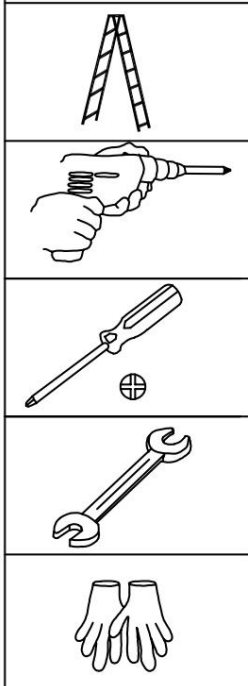
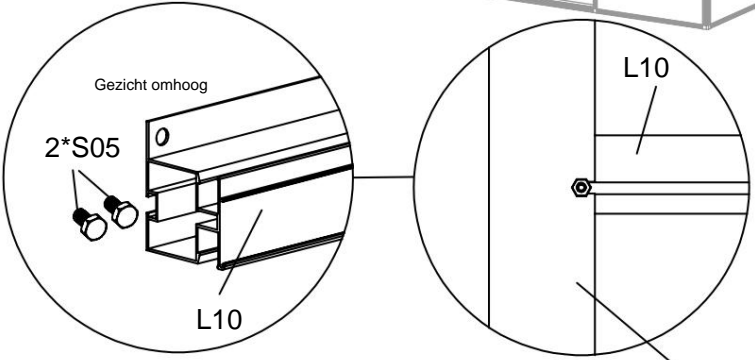
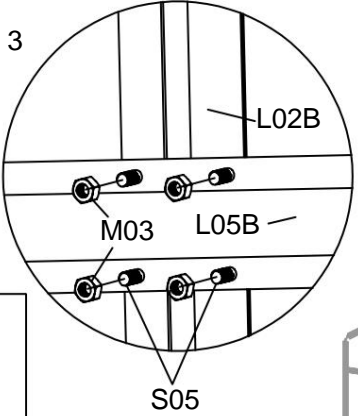
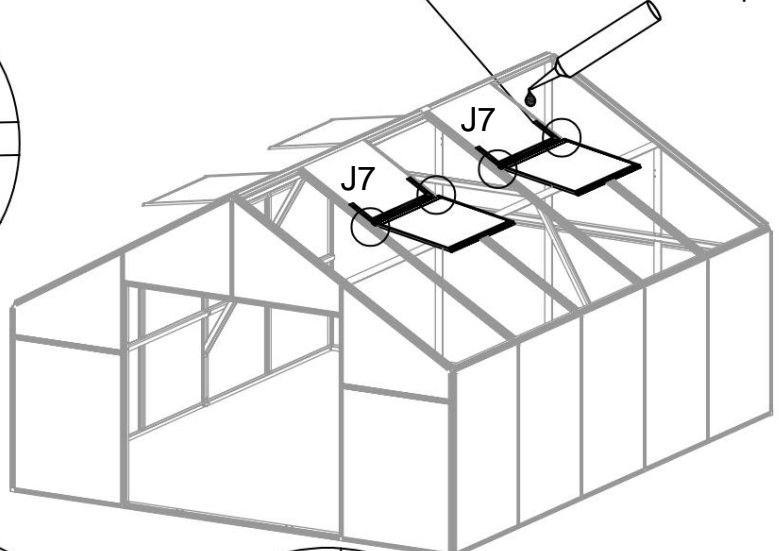





Gebruik waterdichte siliconenkit in de onderstaande positie.

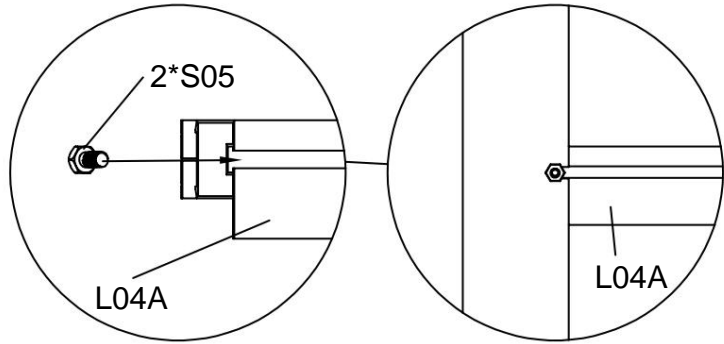
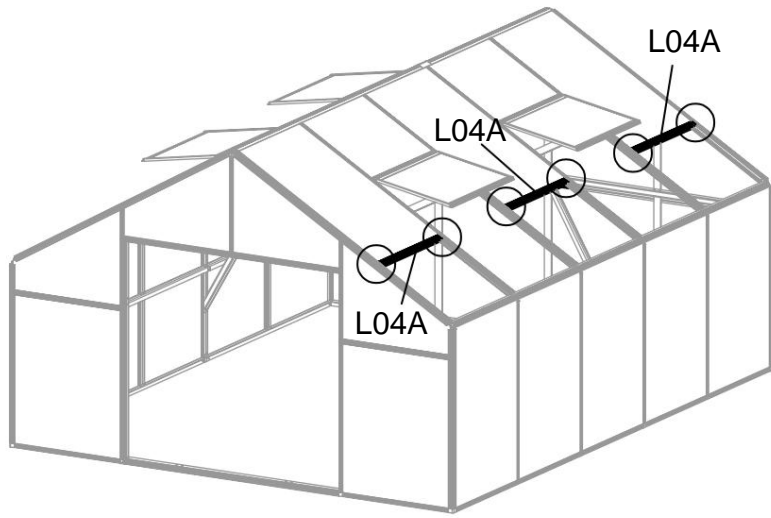
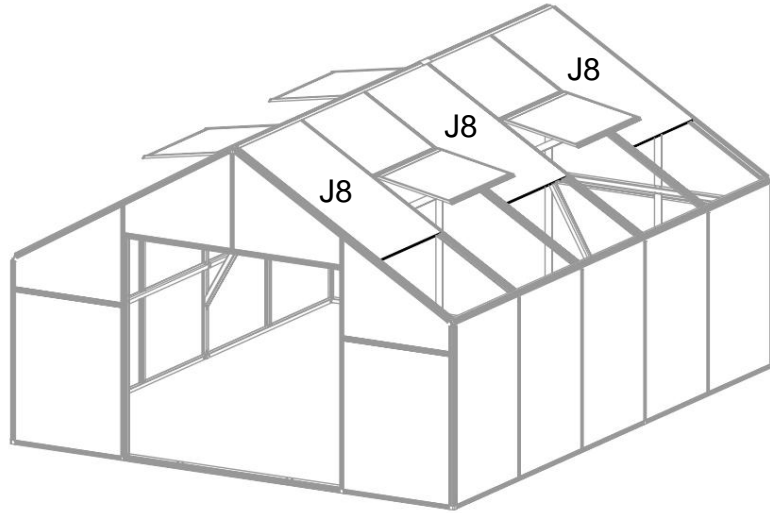

ONDERDEELNR	AANTAL
 L04A	6
 S05 M6X10	12
 M03 M6	12
 J8	6



ONDERDEELNR	AANTAL
	L04A 4
	A03 4
	A04 4
	S05 M6X10 24
	M03 M6 24

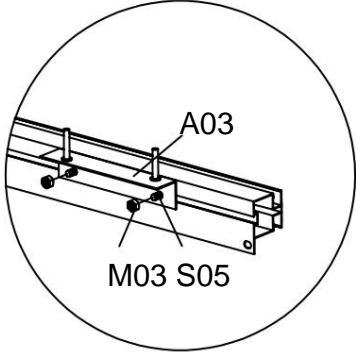
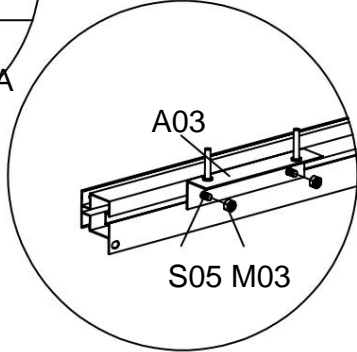
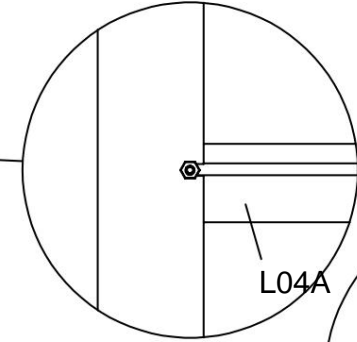
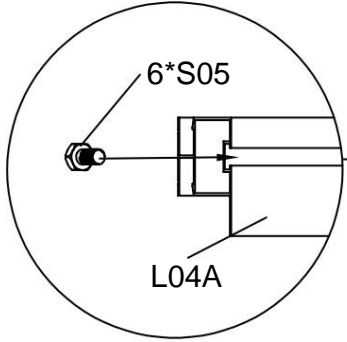
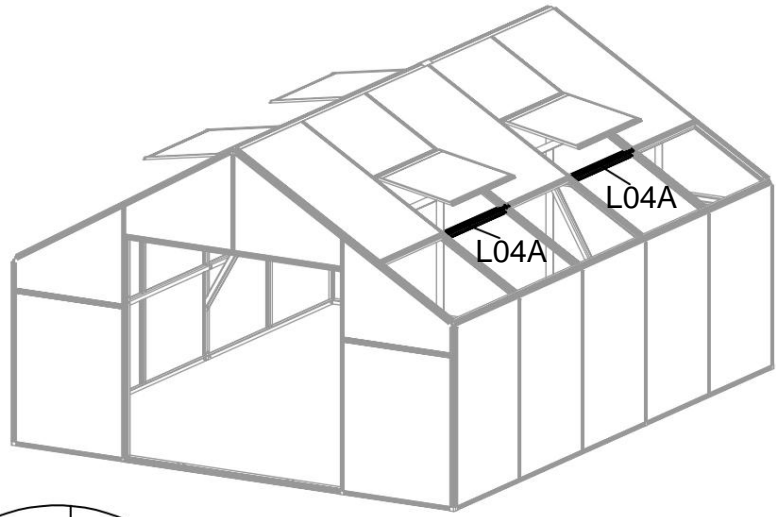

Bevestig A04 en A03 met S05/M03 en pas ze aan zodat ze geschikt zijn voor A01.

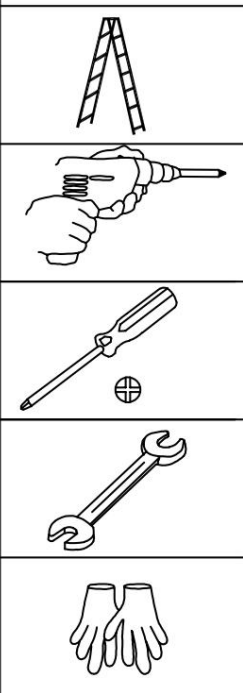
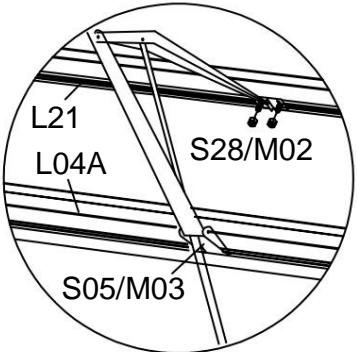
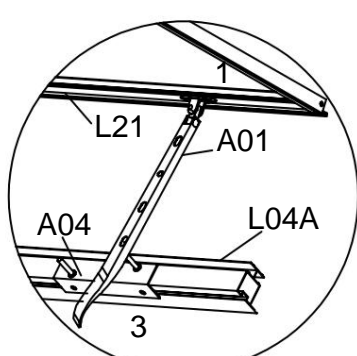
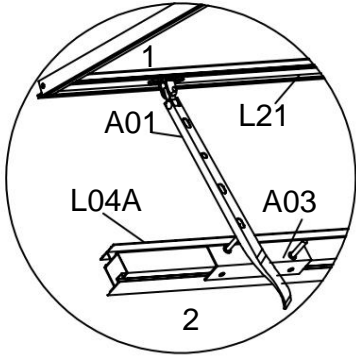







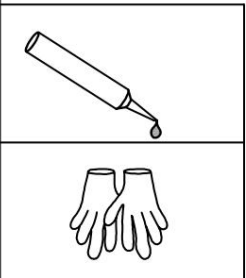
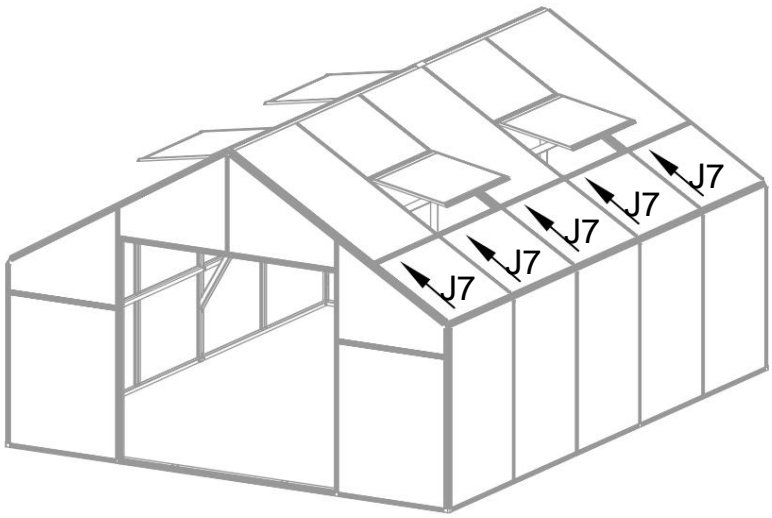
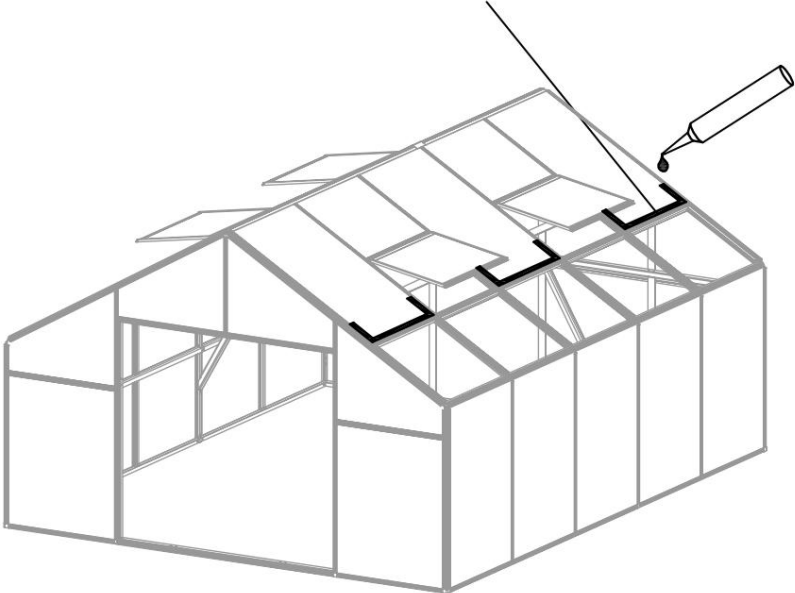



Methoden voor het monteren van de autoopener (niet meegeleverd)

ONDERDEELNR	AANTAL
	J7 10

Gebruik waterdichte siliconenkit in de onderstaande positie na het bevestigen van L04A & L10.





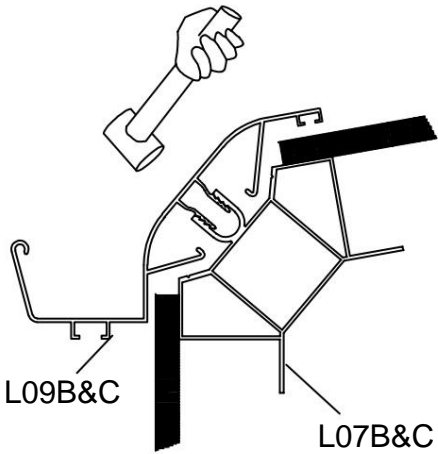
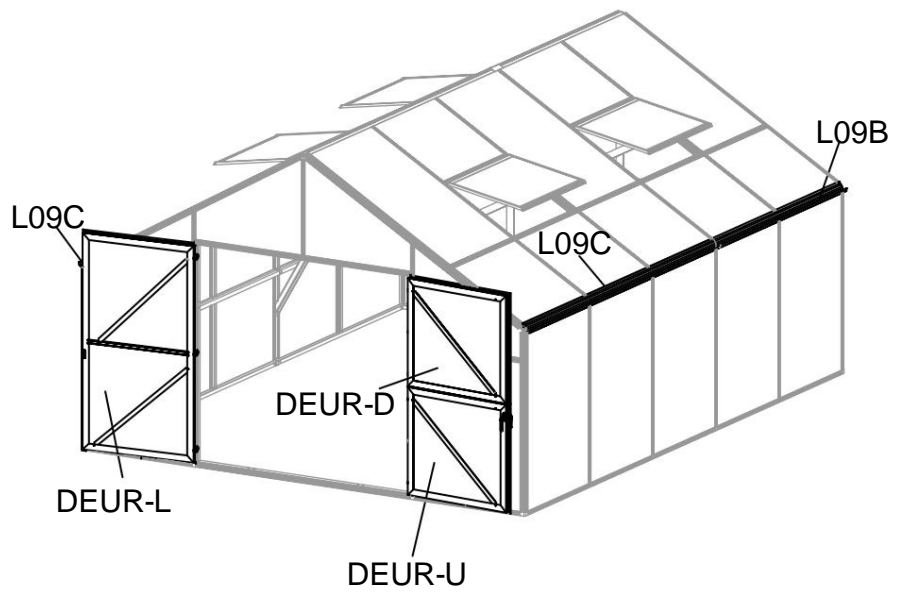



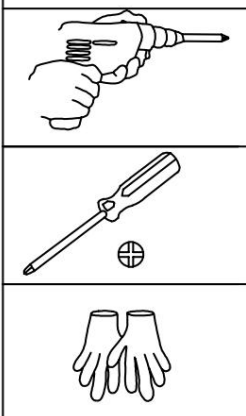
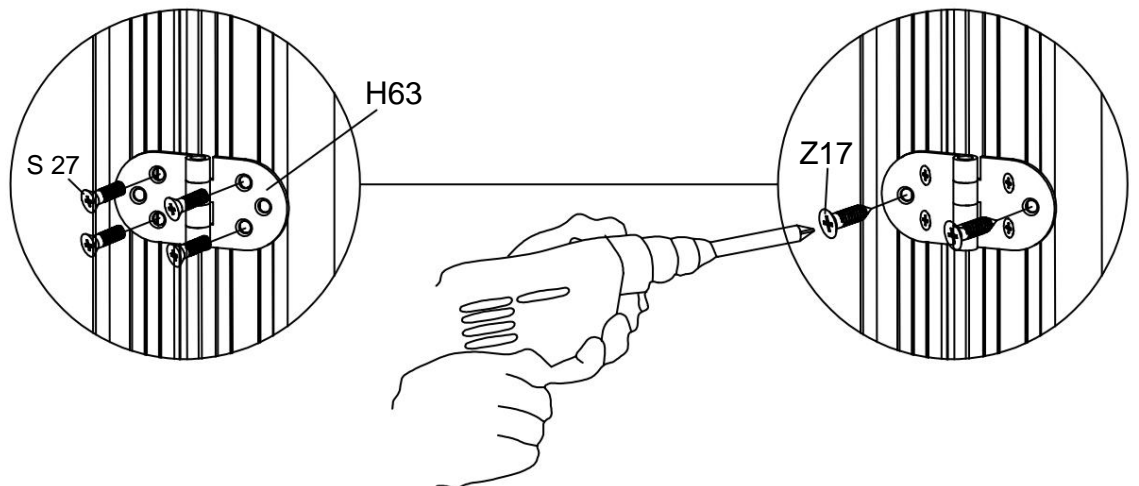
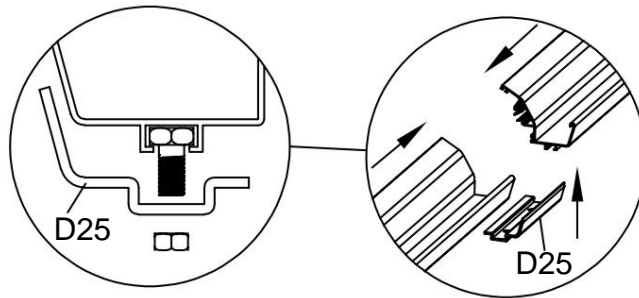



ONDERDEELNR	AANTAL
 H63	9
 L09B	2
 L09C	2
 D25	2
 Z17	18
 M5X12	
 S27	36
 M5X12	
 S05	4
 M6X12	
 M03 M6	4



Wanneer de panelen volledig zijn geplaatst, bevestigt u het gootprofiel L09B&C. Tik het voorzichtig op zijn plaats met een rubberen hamer.



ONDERDEELNR	AANTAL
 J52	2
 J53R	2
 J53L	2
 J94	4
 L30	4
 J93	4
 J92	4
 Z08	4
 M4.2X16	
 Z02	4
 4X14D	

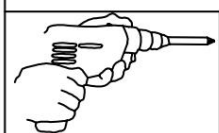
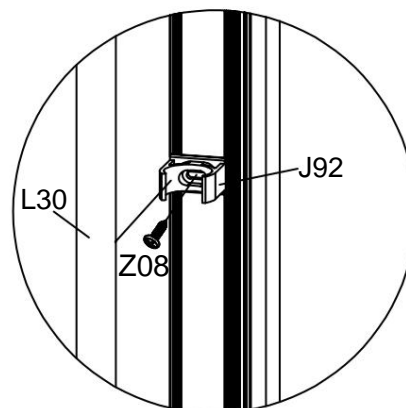
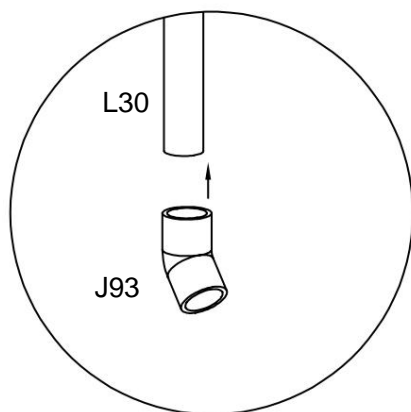
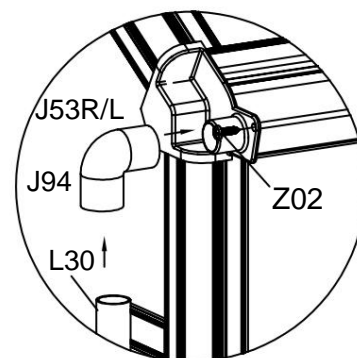
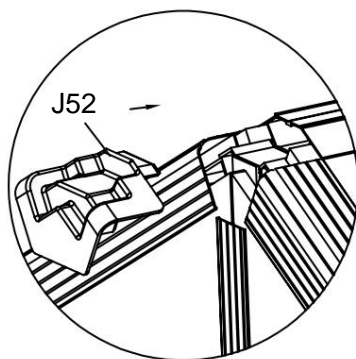
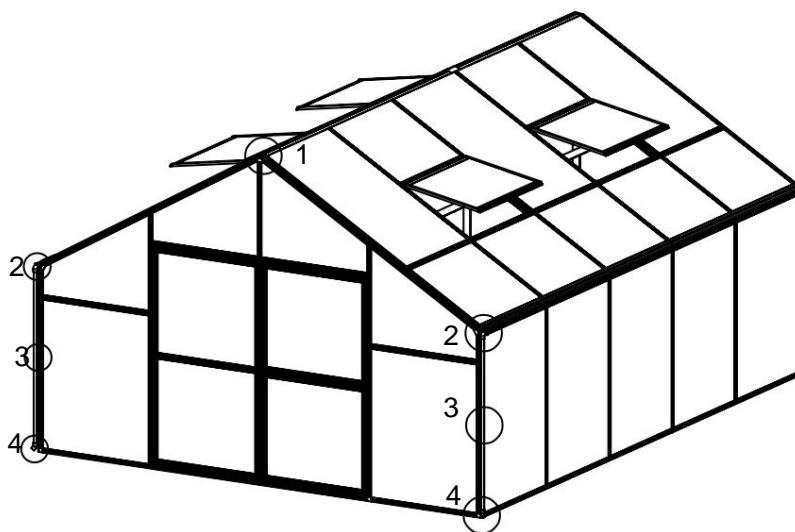

Als u lekken wilt verhelpen, gebruik dan lijm bij het bevestigen van de regenpijpbochten (niet meegeleverd).



Boor een gat in L01A, L01D en L01E, met een diameter van ongeveer 3 mm en 700 mm vanaf de onderkant. Bevestig de J92-afvoerpijpbeugel met Z08-schroeven en klik vervolgens de L30-afvoerpijp in de J92-beugel.

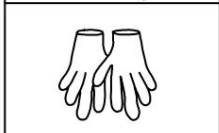



Gardenmeister

Witvrouwenbergweg 13B
5711CN, Someren
Nederland

