

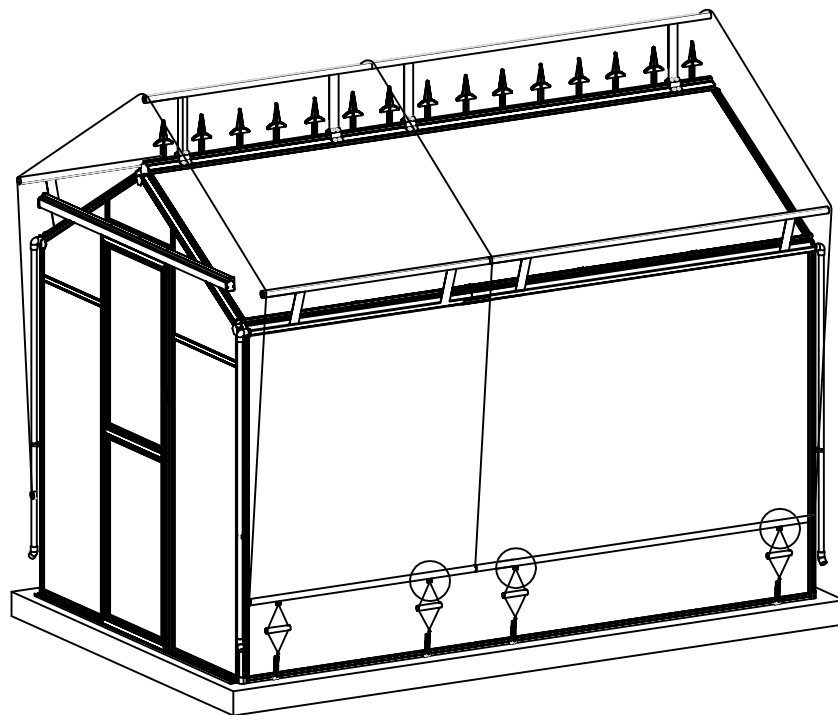

PRESTIGE

Schaduwdoek

Montage handleiding



PRESTIGE 100

















PRESTIGE 300

PRESTIGE 500

















PRESTIGE 700

Onderdelenlijst

Onderdelen voor Prestige 100

Deel	Nr.	Aantal.
	L01A	2
	L02A	5
	Y1	1
	L03A	2
	L03B	4
	W01	4
	W02	4
	W03	4
	W04	4
	W05	5
	W06	4
	W07	2
	S01 M6X16	8
	M01 M6	8
	Z01 Ø5X16	16
	Z02 Ø4X16	10
	J01	10

Onderdelen verlenging

Deel	Nr.	Aantal.
	L01B	2
	L02B	5
	Y2	1
	L03A	2
	L03B	4
	W01	4
	W02	4
	W03	4
	W04	4
	W05	5
	W06	4
	W07	2
	S01 M6X16	8
	M01 M6	8
	Z01 Ø5X16	16
	Z02 Ø4X16	10
	J01	10

Belangrijk:

- ** Lees deze instructies zorgvuldig door voordat u ze in elkaar zet.
- ** Bewaar deze instructies voor toekomstig gebruik.

Benodigde gereedschappen:

- *Schroevendraaier
- *Boormachine
- *Moersleutel

Deel	Nr.	Aantal.
	L01A	2
	L02A	5
	Y1	1
	L01B	2
	L02B	5
	Y2	1
	L03A	4
	L03B	8
	W01	8
	W02	8
	W03	8
	W04	8
	W05	5
	W06	8
	W07	4
	S01 M6X16	16
	M01 M6	16
	Z01 Ø5X16	32
	Z02 Ø4X16	20

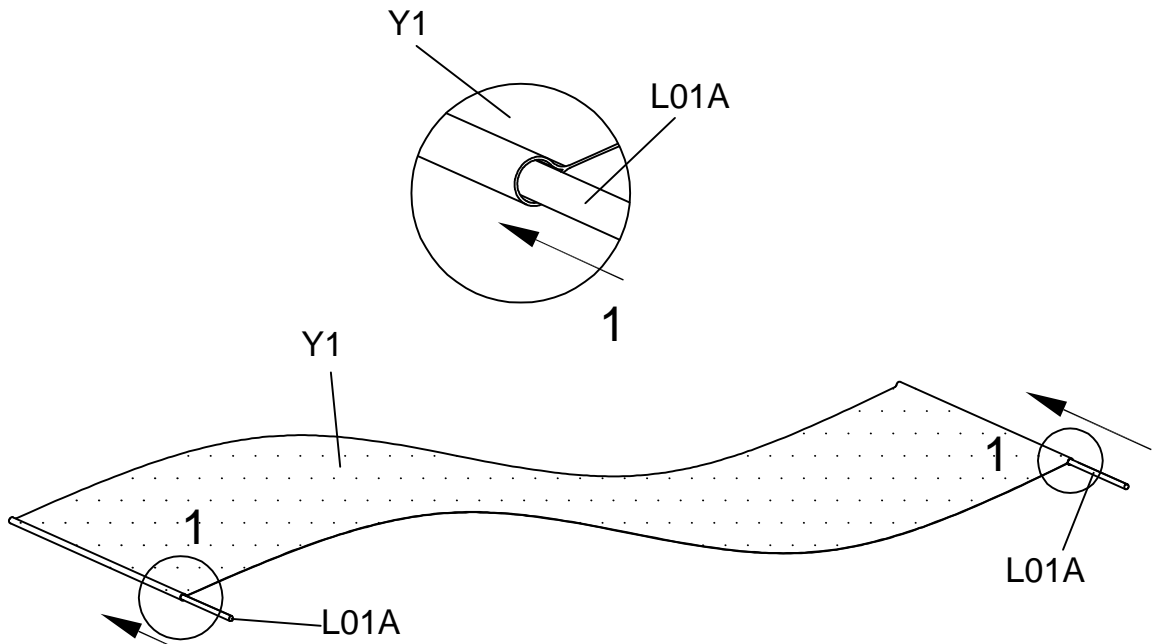

Steek L01A in de zoom van het schaduw materiaal.

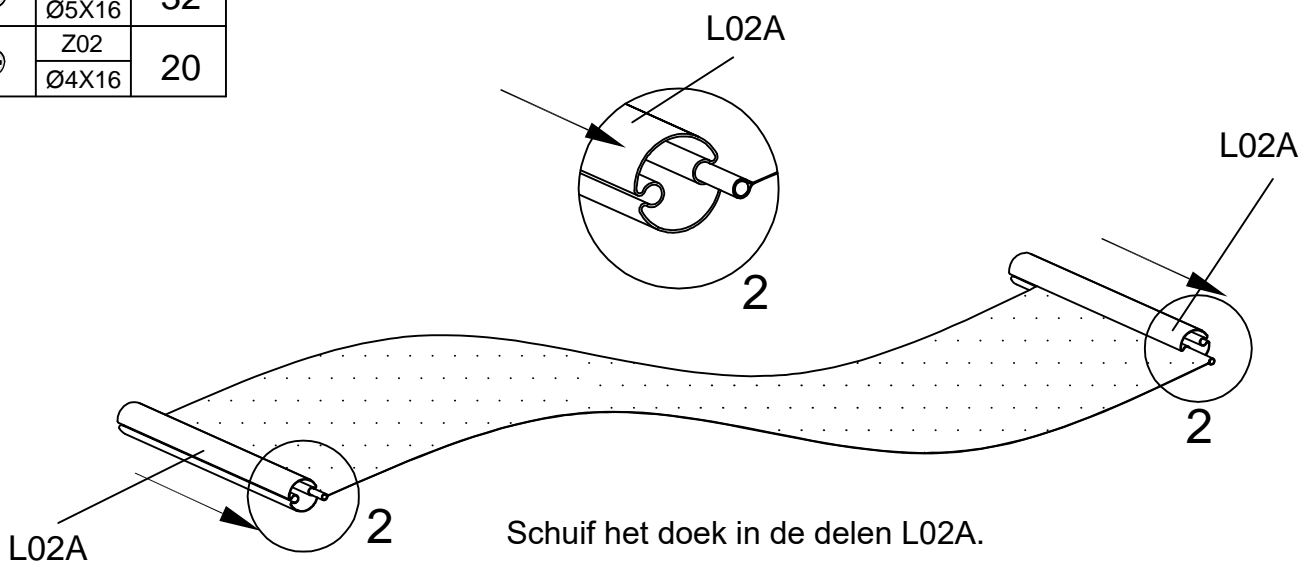

Schuif het doek in de delen L02A.

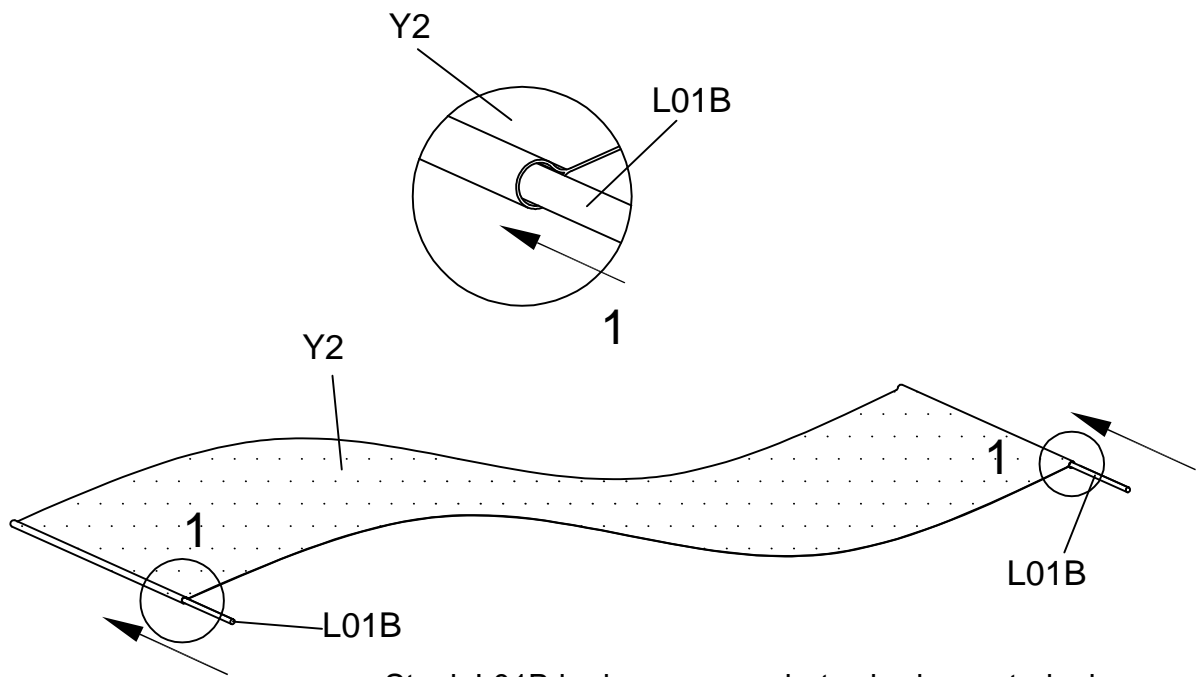

Steek L01B in de zoom van het schaduwmetaal.

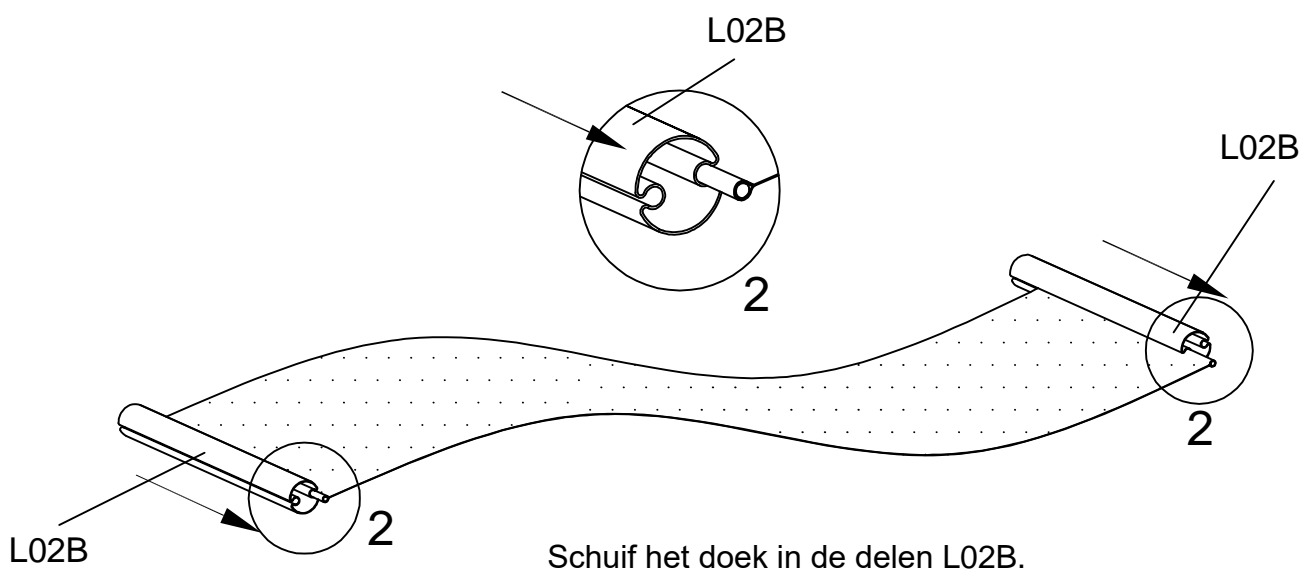

Schuif het doek in de delen L02B.

Nokbeugels (L03A) en dakrandbeugels (L03B) moeten 175mm van het uiteinde van elk nok- en dakrandprofiel. Boor 16 gaten door L03A & W07 in het nokframe en boor ook 16 gaten door L03B in het goot/voetprofiel (zie Fig. hieronder).

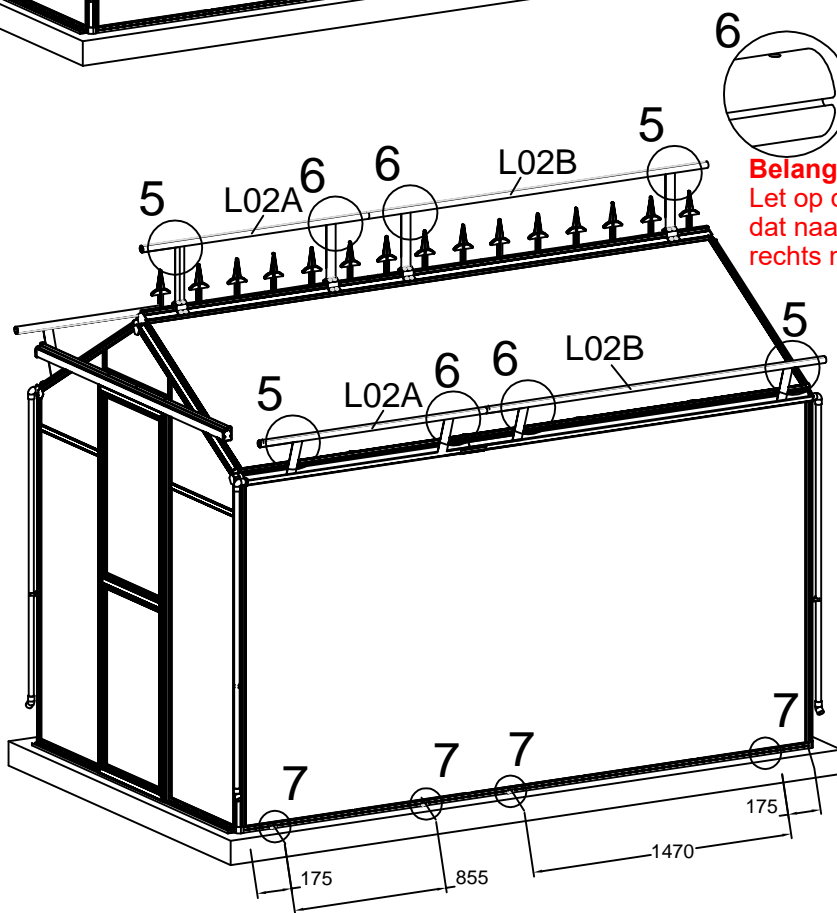
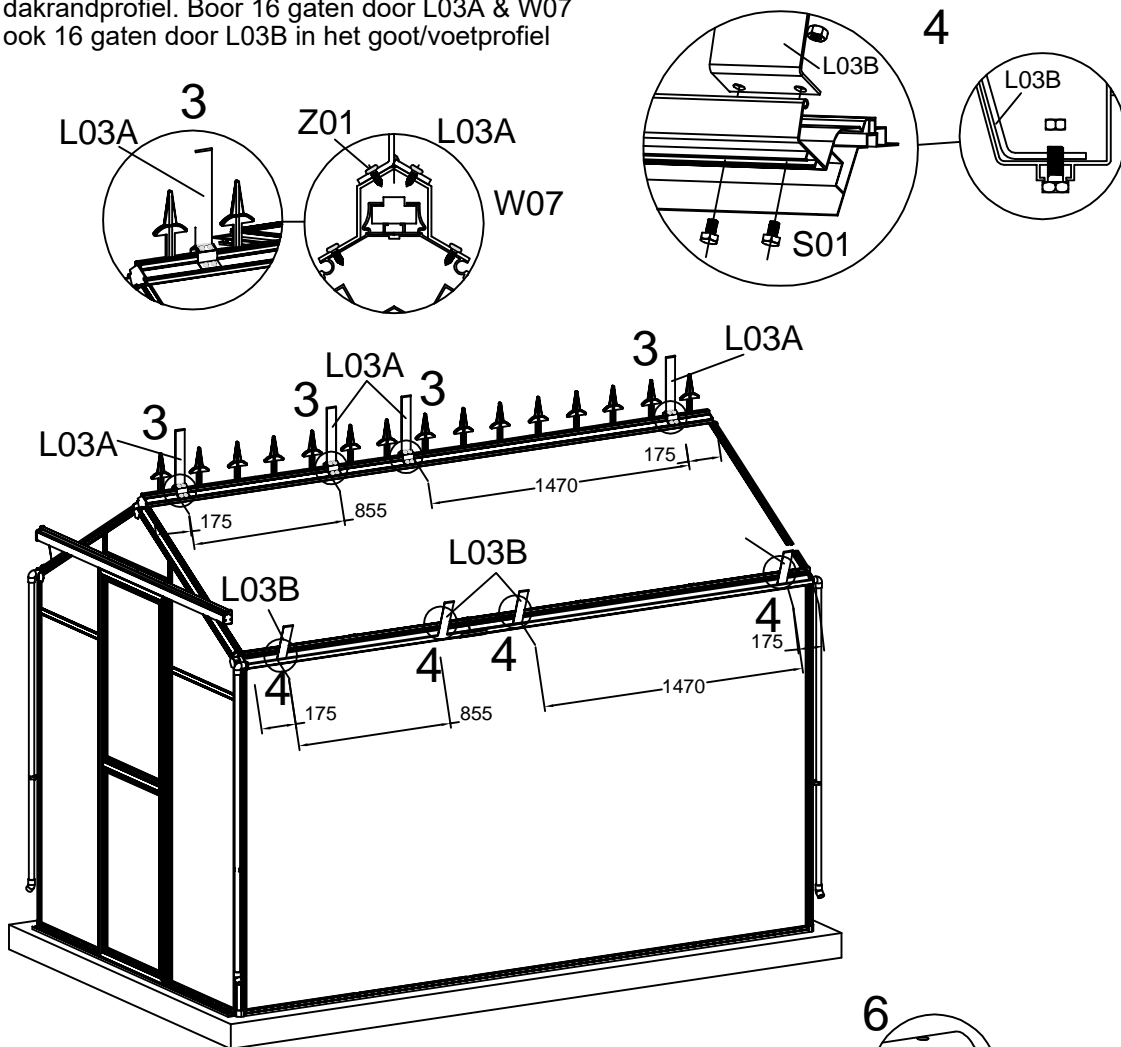

Belangrijk!  Let op dit kleine gaatje dat naar boven en naar rechts moet wijzen.

Plaats een W01 op 175 mm van het uiteinde van elke kasbasis. Boor 16 gaten, Dia. 6mm, door W01 in de basisprofielen (zie Fig. hierboven).

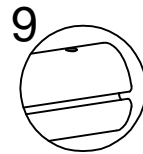
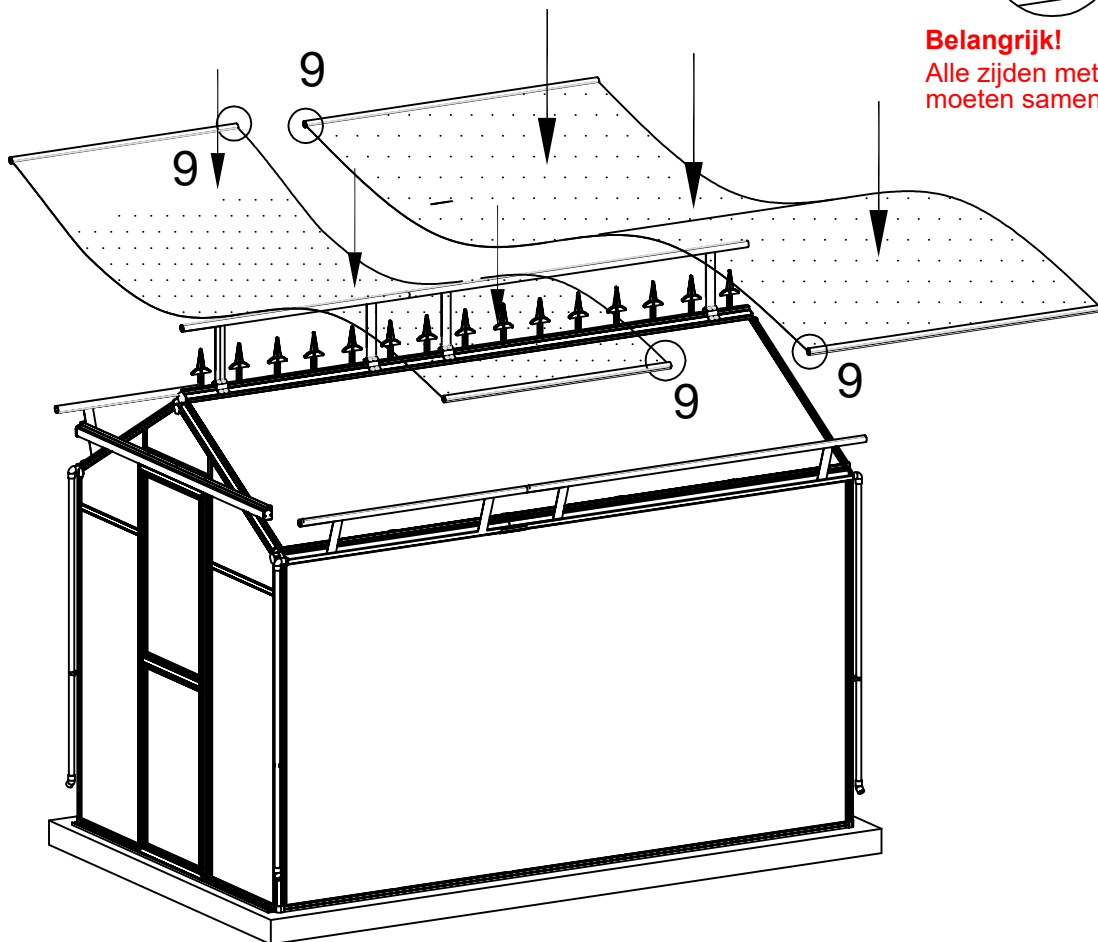
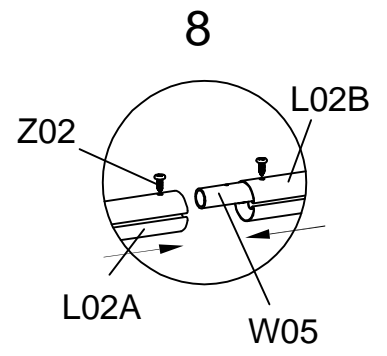
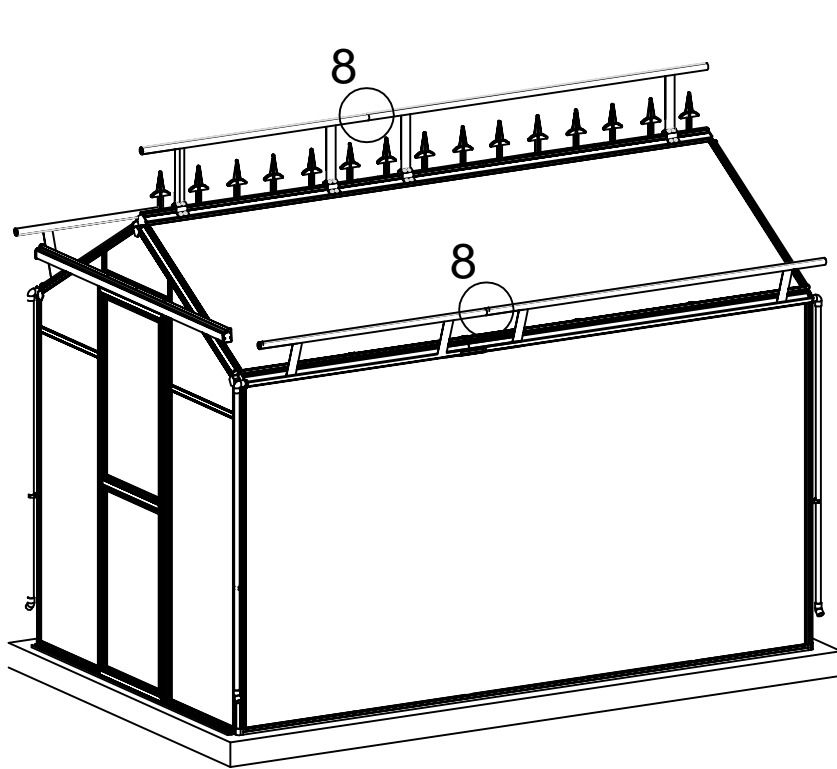

Belangrijk!
 Alle zijden met dit kleine gat moeten samenkomen.

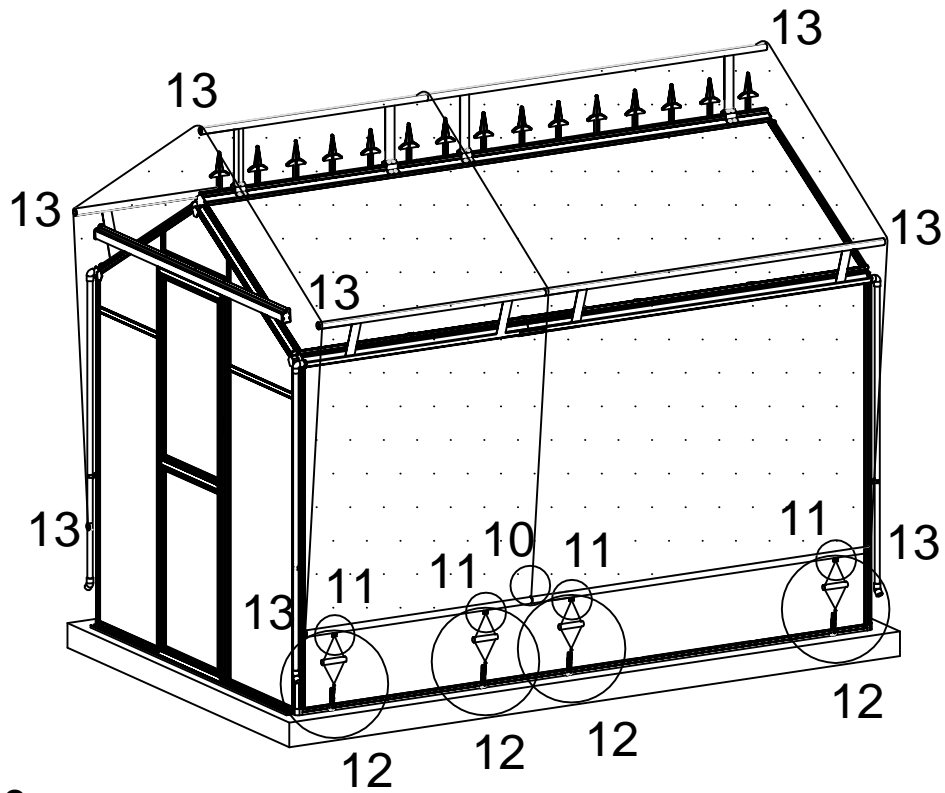

10

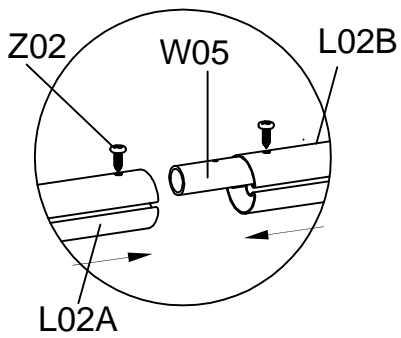

11

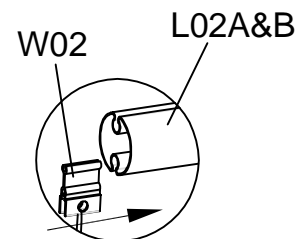

Steek het onderdeel W02 in L02A&B aan elk uiteinde van de schaduwstaaf.
 Monteer vervolgens het touw en de veerspanner, W03, om het schaduwdoek
 stevig op zijn plaats te houden.
 Het is belangrijk dat het schaduwdoek strak over de kas ligt.
 Herhaal dit proces aan de andere kant van de serre.

12

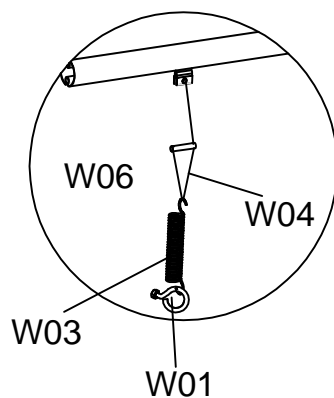

13

